

VII. *On Fibre.* By MARTIN BARRY, M.D., F.R.SS. L. and E.

Received December 3,—Read December 16, 1841.

**T**HERE is scarcely any term so generally used in the description of animal or vegetable tissue, as the term *fibre*. If this serves to show the universal presence of fibre, it also indicates the importance of having a correct notion of its structure. On this subject, however, physiologists differ widely: some believing fibre to be composed of globules, while others maintain that no globules can be discerned in it.

My investigations have led me to adopt neither of these views. Should the observations that I have to communicate be found deserving of attention, it will be owing to my having carefully examined the structure of fibre in the course of its formation, beginning with the very earliest stage. At this period, I had to deal with an object of considerable size; the form of which, therefore, could be distinctly seen: and by tracing the metamorphoses of the large and parent fibre, I was enabled to see in the minute succeeding ones a structure, which I think would not otherwise have been discerned. We may hereafter see the cause of the difference in opinion regarding the structure of fibre.

The present memoir, though devoted to the investigation of fibre, is in fact a continuation of those which I have already communicated to the Society on the Corpuscles of the Blood †.

*Formation of a Flat Filament within the Blood-corpuscle.—Structure of this Filament.—Presence of a Filament having the same appearance in the Coagulum of Blood; as well as in the Tissues generally, of both Animals and Plants.—This Flat Filament is what is usually termed a “Fibre.”*

1. In the mature blood-corpuscle (red blood-disc), there is often to be seen a flat filament or band already formed within the corpuscle. In Mammalia, including Man (Plate V. figs. 4, 1, 2), this filament is frequently annular; sometimes the ring is divided at a certain part; and sometimes one extremity overlaps the other. In Birds (fig. 5.), Amphibia (figs. 8, 9, 10, 11), and Fishes (figs. 12, 13), the filament is of such length as to be coiled.

2. This filament is formed of the discs contained within the blood-corpuscle. In Mammals, the discs entering into its formation are so few as to form a single ring; whence the biconcave form of the corpuscle in this class, and the often annular form

† Part I. Philosophical Transactions, 1840, p. 595, Part II. Philosophical Transactions, 1841, p. 201, Part III. Philosophical Transactions, 1841, p. 217.

of the filament it produces. In the other Vertebrata, the discs contained within the blood-corpuscle are too numerous† for such a ring; therefore their arrangement forms a coil. At the outer part of this coil, the filament (already stated to be flat) is often on its edge (figs. 10, 11, 12), from which arises a greater thickness of the corpuscle, and the appearance it has of being cut off abruptly at this part; while in the centre, there is generally the unappropriated portion of a nucleus (figs. 8, 10): whence the central eminence, around which there appears a depression in those corpuscles that, from the above cause, have the edge thickened.

3. The nucleus of the blood-corpuscle in some instances resembles a ball of twine, being actually composed, at its outer part, of a coiled filament (fig. 10  $\beta$ ,  $\gamma$ ).

4. Such of the Invertebrata as I have examined (figs. 14, 15), likewise present the blood-corpuscle passing into a coil.

5. Acetic acid dissolves the part most advanced, leaving the newest part behind. This accounts for the figures accompanying my Part II. on the Corpuscles of the Blood‡, representing corpuscles of Birds, Amphibia, and Fishes, from which the filament in question, or its elements, had been removed by this reagent.

6. The filament thus formed within the blood-corpuscle, has a structure which is very remarkable (see the figures just referred to). It is not only flat, but deeply grooved on both surfaces; being thereby thinner in the middle than at the edges. The edges are rounded: and when seen on its edge, the filament at first sight seems to consist of segments. It is important, however, to observe, that the line separating the apparent segments from one another, is not directly transverse, but oblique (see fig. 9  $\gamma$ ).

7. Of course the structure of an object so minute, cannot be seen without a very high magnifying power, and a good light. And it may be here remarked, that in the researches forming the subject of this paper, I have generally added dilute spirit (sp. gr. about 0.940), containing about  $\frac{1}{200}$ th of corrosive sublimate§.

8. It is deserving of notice,—in the first place, that portions of the coagulum of blood sometimes consist of filaments having a structure identical with that of the filament formed within the blood-corpuscle; secondly, that, in the coagulum, I have noticed the ring formed in the blood-corpuscle of Man (fig. 4), and the coil formed in that of Birds (fig. 6) and Reptiles, unwinding themselves into the straight and often parallel filaments of the coagulum,—changes which may be also seen taking place in blood placed under the microscope before its coagulation; thirdly, that I have noticed similar coils strewn through the field of view (figs. 7, 17), when examining various tissues,—the coils here also appearing to be altered blood-corpuscles, and

† Philosophical Transactions, 1841, Pl. XVIII. figs. 52  $\gamma$ , 54  $\epsilon$ . In all vertebrated animals the *young* blood-corpuscle is a mere disc, with a depression in the centre. In Mammalia it continues of this form; while in the other Vertebrata it becomes a nucleated cell.

‡ *L. c.*, Pl. XVIII.

§ For the examination of certain tissues, especially muscle, I have since used chromic acid—sp. gr. about 1.050.

unwinding; lastly, that filaments having the same structure as the foregoing, are to be met with apparently in every tissue of the body.

9. I proceed to enumerate the parts in which I have observed the same kind of filaments; without stopping to point out peculiarities in their size or in their mode of combination in the various parts. Future observers will find, that while in some parts they have coalesced to produce a membrane, have themselves passed into tubes, or are otherwise rendered indistinct, they retain their form remarkably, being sometimes crossed in various directions, or at other times lying parallel. Some remarks on this subject will be found in the explanation of the figures, as for instance in that of the cornea (fig. 91). The parts in which I have noticed the filaments in question are these: the cortical and medullary substance of both the cerebrum and cerebellum, the spinal chord, the optic nerve and retina, the olfactory and auditory nerves, nerves connected with the spinal chord, voluntary and involuntary muscle, (the latter including the muscle in all parts of the alimentary canal, and the Fallopian tube and uterus, as well as blood-vessels, the iris and the heart), tendon, elastic tissue, cellular and fatty tissue, serous membranes (peritoneum, pericardium, and arachnoid membrane), various parts of the so-called mucous membrane†, the lining membrane of the large blood-vessels and the valve of a large vein, the skin, the dura mater and the sheath of the spinal chord, ligament, the gums and palate, the stroma of the ovary, the testis and the walls of the vas deferens, the kidney and ureter, the glans, as well as the corpus spongiosum and corpus cavernosum penis, the coats of the gall-bladder and of the cystic duct, the pancreas, the liver. I found them along with the marrow from a bone; between the rings of the trachea, as well as in the substance of the lungs, and the gills of the common Mussel; in the parenchyma of the spleen, the lachrymal gland, the sclerotic coat of the eye, the conjunctiva, the cornea, the membrane of the vitreous humour, the capsule of the crystalline lens, the lens itself, the cartilage of the ear and cartilage of bone, bone itself, the periosteum, the claw of the Bird, the shell-membrane of the egg, substance connecting the ova of the Crab, silk, hair, the incipient feather, the feather-like objects from the wing of the Butterfly and Gnat, and the Spider's web. These are the principal of the animal structures in which I have found filaments such as those above described.

10. Of plants, I subjected to microscopic examination the root, stem, leaf-stalk and leaf, besides the several parts of the flower: and in no instance where a fibrous tissue existed, did I fail to find filaments of the same kind. This was in the Phanerogamia. On subsequently examining portions indiscriminately taken from Ferns, Mosses, Fungi, Lichens, and several of the marine Algæ, I met with an equally general distribution of the same kind of filaments.

11. The flat filament seen by me in all these structures, of both animals and

† I saw a curious interlacement of these filaments on the villi of the lining membrane of the rectum in the Rabbit.

plants, is that usually denominated a "fibre." And the appearance of the filament in all the structures mentioned, was essentially such as that delineated in the figures above referred to : an appearance which I have never before seen represented as that of "fibre."

12. Most of the figures which accompany the memoir present filaments, having the appearance in question. It will be seen to be precisely such as that of the filament formed within the corpuscle of the blood. We know that discoid corpuscles circulate in plants ; and it remains to be seen whether filaments are not formed in these.

The foregoing facts, I think, indicate the necessity in physiological research, of not resting satisfied with mere opinion, though emanating from so high an authority as HUNTER ; who supposed the corpuscles to be "the least important portion of the blood."

*Structure of the Flat Filament ("Fibre") more particularly investigated.*

13. We have hitherto viewed the object called by me a flat filament, only in some of its minutest forms. These are sufficient to show that it is a compound structure. But in order to become more particularly acquainted with this structure, it is requisite to trace the filament into similar objects of larger size. For this purpose, it will be sufficient to examine *successively* the following figures, from nervous substance, from muscle, and from the crystalline lens : namely, figs. 117  $\beta$ , 116  $\beta$ , 115  $\beta$ , 114  $\beta$ , 62, 53, 92, 56, 54, 84, 131.

14. I have attempted in fig. 55. to represent what has appeared to me to be the structure of the objects in the figures now referred to. Here (in fig. 55) we find two spirals, running in opposite directions, and interlacing at a certain point ( $\alpha$ ), in every wind. This arrangement gives to the entire object a grooved appearance and a flattened form. It is in fact the structure which, for want of a better term, I have called a flat filament. The edge of this filament (figs. 114  $\beta$ , 56  $\gamma$ , 62) presents what at first sight seem like segments, but which in reality are the consecutive curves of a spiral thread. A transverse section of such an object is rudely represented by the figure 8. This is precisely the appearance presented also by the minutest filament or "fibre : " and I particularly refer to the oblique direction of the line separating the apparent segments in the smaller filament (fig. 9  $\gamma$ ), in connection with the oblique direction of the spaces between the curves of the spiral threads in the larger one.

15. In further proof of identity in the structure of the larger and the smaller filaments, it may be mentioned that I have seen filaments of minute size to enlarge, and give origin in their interior to other filaments (fig. 131).

16. We shall hereafter find that there is a tendency in these filaments to become membranous at the surface (par. 62). Hence it appears to be, that, very often when the flattened form of the filament and its grooved middle part are distinctly visible, no trace whatever of a crenate edge can be discerned. This may serve to show the necessity for extended observation, before investigators come to a conclusion as to

the existence of filaments, such as those I have described. And here they should be apprized, that the filaments are sometimes exceedingly minute. Such was their condition, for instance, in tendon. In bone also, from which the phosphate of lime had been removed (by muriatic acid), I found them exceedingly minute. The varying appearance of the edges of the filament, just referred to, may assist to explain why some have believed "fibre" to consist of globules; while others have maintained that no globules can be discerned in it.

*The Spiral Form as general in Animals as in Plants—Universality—and Early Appearance of the Spiral Form.*

17. It is known that vegetable tissue presents, in some parts, a feature which has heretofore seemed wanting, or nearly so, in that of animals—the *spiral* form. I venture to believe that some appearances met with in my investigations may go far towards supplying this deficiency. These appearances will be found represented in the nervous tissue (Plates VI., VIII., IX.), in muscle (Plates VI., VII., VIII., IX.), in minute blood-vessels (fig. 16), and in the crystalline lens (fig. 131). If indeed the view above mentioned—that the larger and the smaller filaments have the same structure—be correct, it follows that spirals are much more general in plants themselves than has been hitherto supposed. Spirals would thus appear, in fact, to be as universal as a "fibrous" structure.

18. The tendency to the spiral form manifests itself very early. Of this the most important instance is afforded by the corpuscle of the blood, as above described. I have also obtained an interesting proof of it in cartilage from the ear of a rabbit (figs. 133 to 136), where the nucleus, lying loose in its cell, resembled a ball of twine; being actually composed, at its outer part, like the nuclei of certain blood-corpuscles, of a coiled filament; which it was giving off to weave the cell-wall; this cell-wall being no other than the last formed portion of what is termed the inter-cellular substance—the essential part of cartilage.

19. I think there is ground for believing, that the nucleus of the cell in cartilage, now compared to a ball of twine, is descended by fissiparous generation from the nucleus of the blood-corpuscle; which on a former occasion† we saw to give the first origin to cartilage, for I have never seen the nucleus of a cell arise, except as part of a previously existing nucleus‡. It is therefore interesting now to find in each the appearance which I have compared to a ball of twine: though it is not likely that cartilage is the only tissue to which the blood-corpuscle transmits the property in question.

*Mode of Origin of the Flat Filament ("Fibre")—Its Reproduction.*

20. It is known that, in order to the formation of certain fibrous tissues, cells

† Philosophical Transactions, 1841, Pl. XXII. figs. 116½—122.

‡ Some of the nuclei in the cells of cartilage in figs. 134, 135, were apparently undergoing division.

apply themselves to one another (fig. 28), so as to present the appearance of a necklace; and that subsequently, as the partitions between the cell-cavities are absorbed, this necklace becomes a tube. It is supposed that the ultimate threads of the tissue arise within this tube. But on the subject of the particular mode of origin of these ultimate threads, I am not aware that we possess any published information, except that furnished by SCHWANN and VALENTIN: the former having shown that a "secondary deposit" makes its appearance on the inner surface of the wall of the tube †, and the latter, that this deposit soon presents longitudinal threads; which threads have sometimes the appearance of being "composed of longitudinal rows of globules ‡." I do not find that any mention has hitherto been made of a *second* order of tubes, arising within the first or parent tube (par. 42). The results obtained by myself are by no means complete; but may perhaps afford information that will serve as a guide in future investigations.

21. Cells applied to one another in the above necklace-like manner, I formerly showed to become filled with discs §. If now fig. 26  $\gamma$  be referred to, such discs—or cells into which the discs have passed—will be seen arranged in lines, corresponding with the direction of the forming tube. This figure was taken from the mould of cheese. Fig. 36 presents an arrangement of the same kind, noticed in voluntary muscle.

22. One of the purposes for which this linear direction occurs, seems to be the production of smaller tubes within the larger one (fig. 30); and another purpose is apparently a peculiar arrangement of discs within the smaller tube. Such an arrangement is seen in figs. 45 to 48. In some of these, the discs had become rings. The structure of these rings was such as to leave no doubt with me, that the same process was in operation as that producing the changes, above described, in corpuscles of the blood. The blood-corpuscle (fig. 17  $\alpha$ ) passes from a mere disc into a ring ( $\beta$ ,  $\gamma$ ), and this ring into a coil ( $\delta$ ,  $\epsilon$ ,  $\epsilon$ ). Now, with the regular arrangement of rings seen at  $\alpha$  fig. 48, and with the analogy of the blood-corpuscles just mentioned, it seems highly probable that every ring (fig. 48  $\alpha$ ) becomes a coil, and that the extremities of coils in the same line unite, to form a spiral. I have to add, that a spiral ( $\gamma$ ) actually existed in this tube (fig. 48) in a line with the rings represented in the figure, having obviously been formed out of such rings: and I know of no way in which the transformation could have been effected so easily and so naturally as that now described.

23. The tube in question (fig. 48) presents, not merely one, but *two* spirals: and these two spirals interlace with one another. This interlacement seems to explain

† SCHWANN, "Mikroskopische Untersuchungen über die Uebereinstimmung in der Struktur und dem Wachstum der Thiere und Pflanzen." Tab. IV. fig. 3.

‡ VALENTIN, in MÜLLER'S Archiv, 1840, p. 204. My observations are entirely different from those of VALENTIN as to the office performed by the nucleus of the cell.

§ "On the Corpuscles of the Blood," Part III., *l. c.*, par. 161.

the remarkable arrangement of the two lines of rings at  $\alpha$ . For, during the transition (as I suppose) of the rings into coils, an interlacement is almost a necessary consequence of the alternate succession of the rings. I have also seen this interlacement of spirals provided for, apparently, by the rings of several lines being linked together while still rings (fig. 47: see also fig. 120).

24. Figure 48, from its exhibiting only one side of the tube, represents but two rows of rings. The number of rows, however, contained in the tube seemed four: which of course would become connected in the above way, as easily as two; and give origin to a corresponding number of interlacing spirals.

25. I cannot suppose that minuteness is any hindrance to the smallest filament ("fibre") having its origin *by the same mode: and to this, the linear arrangement of the discs within the blood-corpuscle seems to have especial reference*†. Facts will be hereafter mentioned, which seem to show a *fasciculus* of filaments to be thus produced in a certain tissue (par. 42—44).

26. Within the windings of the spirals (fig. 57  $\alpha$ ), nuclei are sometimes to be discerned. It appears to be from these nuclei that there proceeds the substance for forming new filaments (fig. 22); which are very often seen within the winds of spirals (figs. 131  $\beta$ , 94, 58).

27. I have in some instances observed the filaments, when enlarging, to present a remarkable change in the relative position of their spiral threads. If figs. 40, 41 be referred to, it will be seen that  $\alpha$  of fig. 40 passes into  $\alpha$  of fig. 41, and the latter into  $\beta$  of the same figure. The scheme fig. 60 may illustrate this transition. This scheme is merely an altered state of that in fig. 55. In each there are two spirals; the difference consisting in the relative position of the spirals. The points in contact at  $\alpha$  fig. 55, have separated in fig. 60 ( $\alpha$ ,  $\alpha$ ); so that now, a transverse section is no longer represented by the figure 8 (par. 14), but by a circle. This latter (fig. 60) seems to exhibit the relative position of the spirals, in some instances, when they begin to form, as will be hereafter shown, the membrane of a tube. Such appears to be their state in fig. 41.  $\beta$ : a state which apparently precedes the formation of the tubes in figs. 42, 43, and the subsequent figures in this Plate.

#### *Facts observed in the Formation and Structure of Nerve.*

28. It is known that in the so-called "primitive fibres" into which a nerve can be separated by means of needles, REMAK demonstrated a "band-like axis‡," corresponding to the "cylindrical axis of PURKINJE‡;" and that the substance surrounding this axis, has been termed by SCHWANN, the "white substance of the nervous fibre‡." This "white substance" I find to consist of filaments (fig. 112  $\alpha$ ,  $\beta$ —fig.

† See my Part III. on the Corpuscles of the Blood, Philosophical Transactions, 1841, Plate XVIII. figs. 52  $\gamma$ , 54  $\epsilon$ .

‡ MÜLLER's Elements of Physiology, translated by Dr. BALY, Part VI. p. 1649.

102  $\alpha$ ,  $\beta$ ,  $\gamma$ ), having the same structure as those constantly referred to in the present memoir. These filaments, forming the white substance of the nervous fibre, are often seen to be curiously interlaced (fig. 102  $\gamma$ ), as though each filament had a spiral form. In other instances their direction is more longitudinal (fig. 112  $\alpha$ ).

29. Professor MÜLLER justly says, "The great size of the so-named primitive fibres of the nerves, as compared with the minute elementary parts of muscles, the cellular and other tissues, excites a doubt as to whether the fibre contained in the nervous cylinder is really its most minute element †." He states that "in fibres of the thickness of the ordinary primitive fibres, which SCHWANN examined in the mesentery of the Frog, he saw other much finer filaments which issued from the larger fibre ‡." To the filaments seen by SCHWANN, I shall refer in a future page. MÜLLER adds, that "TREVIRANUS observed in several nervous cylinders streaks running longitudinally, and he even saw distinctly more minute elementary filaments in the so-called primitive cylinders §."

30. The filaments noticed by TREVIRANUS, I think may have been the flat filaments in question. But these flat filaments, as we have seen, have themselves a compound structure.

31. It is very common to find the nerve-cylinder ("primitive fibre") drawn out to a point from manipulation, like the fasciculus of muscle. See remarks on the alteration of the spirals in the muscular fasciculus, and on the office performed by the investing membrane, in this change (par. 54).

32. The filaments in fasciculi from the optic (fig. 107), olfactory (fig. 108), and auditory nerves, have appeared less tense than those in the common spinal nerves; and there has been a less decided appearance of membrane at the surface in the former.

33. In examining the substance of these soft nerves, as well as that of the brain and spinal chord, I have employed for the most part such as had been preserved in spirit: and, besides using extremely minute portions, I have very often found it needful to avoid adding any covering whatever; the weight of thin mica itself being sufficient to rupture or to flatten it, and thus entirely prevent the structure from being seen. I have already stated it to have been my general practice in these examinations, to add corrosive sublimate dissolved in dilute spirit (par. 7).

34. In the substance of the brain and spinal chord, I have usually met with a very large number of discs (fig. 17  $\alpha$ ,  $\beta$ ), which from their colour, size, and general appearance (corresponding in these respects with many of the corpuscles within the blood-vessels of the pia mater), seemed to be young corpuscles of the blood. Along with these were rings ( $\gamma$ ) and coils of filaments ( $\delta$ ,  $\epsilon$ ,  $\epsilon$ ), into which the discs appeared to pass. I have noticed similar rings in the auditory and optic nerves; and coils, as well as rings, in the retina (fig. 18), these coils being of the colour of the blood-corpuscle. Sometimes the coils (fig. 21) are very thick, and comparable to coils of rope.

† Elements of Physiology, translated by Dr. Baly, Part III. p. 597.

‡ Ibid. pp. 597, 598.

§ Ibid. p. 598.



35. The constant presence in these parts, of discs, rings, and coils, makes it difficult to avoid connecting them with such objects as that in fig. 22: the outer spiral in which, for instance, may represent an advanced state of coils like those in fig. 21. Spirals were present between  $\alpha$  and  $\beta$  in fig. 22; but they have not been delineated.

36. In fig. 80  $\gamma$ , is a broad band-like axis, consisting of delicate longitudinal filaments, and having filaments ( $\beta$ ) external to it; these being surrounded by a spiral ( $\alpha$ ). The broad band-like axis ( $\gamma$ ), I think may correspond to that of REMAK above referred to; the "white substance" of SCHWANN being here represented by the filaments  $\beta$  and  $\alpha$ . If, however, this analogy exists, my observations go farther even than REMAK'S. The axis described by this observer was found by him to be susceptible of division into filaments. So also is the one described by myself (fig. 80  $\gamma$ , 81  $\beta$ , 85  $\beta$ ). But what I add is that each filament is a compound body, that enlarges (fig. 86), and, from analogy, may contain the elements of future structures, formed by division and subdivision to which no limits can be assigned.

37. The filaments  $\beta$  in fig. 85, being of far minuter size than the so-called "primitive fibre" of the nerves (figs. 102, 112  $\alpha$ ,  $\beta$ ), I think it possible that the filaments referred to in a former page, as seen by SCHWANN to proceed from one of the ordinary "primitive fibres" in the mesentery of the Frog, may have had a similar mode of origin.

38. It has been already stated that the filaments which I believe to constitute the "white substance of nervous fibre," are often seen to be, not longitudinal, but curiously interlaced (fig. 102  $\gamma$ ), as though each filament ran in a spiral direction. The appearance has been very much like what would be produced by an elongation of the spirals in fig. 60 (compare this with fig. 102  $\gamma$ ), supposing many spirals to be present instead of two. Now fig. 60, though ideal, represents, apparently, no more than an advanced state of the object fig. 22. In fig. 22 the spirals  $\alpha$  and  $\beta$  run in opposite directions; and were  $\beta$  to have attained the size of  $\alpha$ , we should have fig. 60, with a central row of nuclei for the production of other spirals, which spirals would make the resemblance to fig. 102.  $\gamma$  still more complete†.

39. The frequent interlacing (fig. 102  $\gamma$ ), and apparently spiral direction, of the filaments in nerves, now referred to, seems the more deserving of attention, from my having found spirally directed filaments so very general in the retina, brain, and spinal chord (figs. 17 to 22, 72, 77, 80 to 82, 85, 99). Farther, I have noticed spirally directed filaments, on being broken, to recoil (figs. 80, 81). Such a change in the "white substance," taking place within a tube, might produce varicosities; and those minute isolated masses, hitherto called granular, by which it has been usual to distinguish nerve.

40. In the course of my investigations, I met with a curious object in the lachrymal gland, more resembling a nerve than any other structure, the appearance of which

† As already mentioned, there were spirals between  $\alpha$  and  $\beta$  in fig. 22; which I have not introduced. Their presence gives an additional resemblance to fig. 102  $\gamma$ . From the above remarks, it appears that a state like that in fig. 60 may be produced in two ways. See par. 27.

I am acquainted with. This body, sketched in fig. 118, was composed of flat filaments ( $\beta$ ,  $\gamma$ ), and had a loop-like termination, to the very extremity of which,—that is, into the loop itself,—the filaments in question were continued, and which indeed they formed. Nothing was seen in this object besides filaments, longitudinal and spiral, for no membranous covering could be discerned. A remarkable crossing of the filaments of opposite sides ( $\alpha$ ), was noticed between the trunk of this object and its loop.

*Facts observed in the Formation and Structure of Muscle.*

41. In May 1840, I offered to the Society some remarks on the origin of muscle<sup>†</sup>, in which it was mentioned that I was then unable to state the mode of formation of the fibrillæ within the cylinder. Subsequent observations, to be presently detailed, seem to throw some light upon that subject. In the mean time, however, a memoir by W. BOWMAN has been read, “On the Minute Structure and Movements of Voluntary Muscle<sup>‡</sup>.” This circumstance would have inclined me not to return to the subject, but for its essential connection with researches previously begun by myself; namely, those “on the Corpuscles of the Blood:” and in recording the results, I perceive with regret that in the main points they are at variance with the observations of the author just mentioned.

42. The arrangement of cells into a necklace-like object, has been referred to in a former page (par. 20): and though I have delineated cells in this state in two previous memoirs<sup>§</sup>, they are sketched in outline in the present paper, fig. 28; which represents cells derived from blood-corpuscles of the Frog. These corpuscles or cells were filled with discs (fig. 29), arisen out of the nuclei of the cells. On the disappearance of the *septa* between the cells, there is formed a tube. In early stages, this tube becomes broken, by manipulation, into fragments (fig. 30); which fragments represent, apparently, an altered state of the original cells. Within the tube there arise other tubes (see the columns in fig. 30), having their origin in the discs with which the original cells were filled. These inner or second tubes (figs. 32, 33) are met with in after stages, no longer breaking transversely into fragments, but easily separating in a longitudinal direction. Within these second tubes are nuclei (figs. 42 to 44  $\alpha$ ), which divide, subdivide (fig. 42) ||, and give origin to discs. The discs fill the tube, arranging themselves with curious regularity (fig. 44  $\beta$ ), and in a manner similar to that represented by me in the Philosophical Transactions for 1841 ¶, as the state of blood-red discs in tubes at the edge of the crystalline lens. These discs appear to undergo changes like those passed through by their progenitors, the corpuscles of the

† In my first paper on the Corpuscles of the Blood, *l. c.*, p. 605.

‡ Philosophical Transactions, 1840, p. 457.

§ Philosophical Transactions, 1840, Plate XXX. figs. 14—17; 1841, Plate XXIII. figs. 135, 136.

|| We thus find the same process in operation here, which I formerly described as taking place in the so-called “primary” cell,—namely, division of the nucleus.

¶ Plate. XXIV. figs. 145—148.

blood: they become rings (fig. 48  $\alpha$ ); the rings pass into coils; and the coils unite, thus forming spirals ( $\gamma$ ). The adjacent spirals interlace, from the peculiar arrangement, in relation to one another, of the rows of rings (par. 23). In the space circumscribed by the windings of these interlaced spirals, smaller spirals have their origin; these in turn give origin to others; and so on. An example of this, in a later stage, is afforded by fig. 58. Here,  $\alpha$  represents the outer or larger spirals; and  $\beta$  the situation of the inner or smaller ones. The outer spirals gradually disappear, *by entering into the formation of the common investing membrane* discovered by SCHWANN, and in its formed state well described by BOWMAN, who proposes to denominate it the "sarcolemma $\dagger$ ." This may perhaps explain the mode of origin of the darker of the longitudinal striæ, three of which are represented in fig. 63 ( $\beta, \beta, \beta$ ): these being apparently the situations of membranous partitions or *septa* (par. 53), passing into the interior of the fasciculus from the common investing membrane.

43. The process just mentioned, of smaller spirals arising in the space circumscribed by the larger ones, with the gradual disappearance of the latter, seems to be continued in later stages $\ddagger$ . The number of the spirals becomes continually greater, and their size more and more minute (figs. 95, 58, 65), until they reach the number and minuteness represented in figs. 96, 63: and they attain even a smaller size.

44. The outer spirals being formed of the outer or ring-like portions of the discs (fig. 48  $\alpha$ ), the inner spirals appear to have their origin in the inner part, or nucleus of these discs: and when the inner spirals in their turn enlarge, and new ones form in their interior, the origin of the new spirals, also, seems to take place in the line of continually renovated nuclei; and so on.

45. Fig. 63. presents a state of the muscle-fasciculus, in which it contains what is denominated the "fibril," of a very minute, though not the minutest size. This "fibril" is no other than a state of the object which I have called a flat filament: and which, as we have seen, is a compound structure. The figure (fig. 55) and description (par. 14) by which I have endeavoured to explain the structure of the filament, are especially applicable to the muscular "fibril." This "fibril" I find to be, not round and beaded, as it has been supposed, but a flat and grooved filament, consisting of two spiral threads, running in opposite directions, and interlacing at a certain point ( $\alpha$  fig. 55) in every wind. A transverse section of this filament, as before mentioned, is rudely represented by the figure 8  $\S$ .

$\dagger$  SCHWANN is the discoverer of this membrane; but we are indebted to BOWMAN for the only complete description hitherto given of it in a formed state. Its mode of origin however, out of spirals, is for the first time described in the present memoir.

$\ddagger$  In young fasciculi I have noticed a transverse space to extend far into the interior; which is not the case in those more advanced, the cause being the disappearance of the outer and larger spirals, and the continual formation of inner and smaller ones.

$\S$  I have often seen a filament ("fibril") becoming a *fasciculus* (par. 44). See figs. 56, 57, 84, 64  $\gamma$ . Enlarged filaments are well seen in the heart of the Turtle.

46. This flat filament is so situated in the fasciculus of voluntary muscle, as to present its edge to the observer (fig. 62); the curves of only one of its two spirals being seen. After removal, also, from the fasciculus, the filament very frequently lies, more or less, upon its edge. It seems to have been the appearance presented by the edge of this filament—that is to say, by the curves of a spiral thread,—that suggested to SCHWANN the idea of longitudinal bead-like enlargements of the fibril, as producing striæ in the fasciculus of voluntary muscle.

47. In my opinion, the dark *longitudinal* striæ are spaces (probably occupied by a lubricating fluid) between the edges of flat filaments, each filament being composed of two spiral threads: and the dark *transverse* striæ, rows of spaces between the curves of these spiral threads. If the *dark* longitudinal striæ are spaces between the edges of flat filaments, it follows that the *light* longitudinal striæ are the edges themselves of these filaments. And if the *dark* transverse striæ are rows of spaces between the curves of spiral threads, the *light* transverse striæ are of course the visible portions themselves of these spiral threads.

48. I repeat, that the longitudinal filament in the fasciculus of muscle, appears to be composed of two spiral threads, only one of which is seen, from the edge of the filament being directed towards the observer. This filament, or its edge, seems to correspond to the *primitive marked thread* of FONTANA; to the *primitive fibre* of VALENTIN, and SCHWANN; to the *marked filament* of SKEY; to the *elementary fibre* of MANDL; to the *beaded fibril* of SCHWANN, MÜLLER, LAUTH, and BOWMAN; and to the *granular fibre* of GERBER.

49. In the Philosophical Transactions for 1840 (p. 605), I suggested that, were the nucleus of the blood-corpuscle the seat of changes such as I had witnessed and described in other cells, the nucleus might produce the muscular fibril. The foregoing observations show that the conjecture then offered has been realized: but, I must add, in a most unexpected manner.

50. The chief physiological inferences deducible from a spiral form of the finest threads of muscle, will I think be obvious. At all events, it would be premature for me to introduce remarks on this subject at any length, before my researches are confirmed by those of other observers. Yet there are two or three conclusions that seem called for, in connection with the foregoing facts.

51. Every one knows that in proportion as a spiral is shortened, the spaces between the curves of the spiral are made smaller, and the diameter of the spiral expands: while, in proportion as the spiral is lengthened, as by removing further asunder its two ends, the spaces between the curves of the spiral are made greater, and the diameter of the spiral is diminished. This may serve to illustrate what takes place in a muscle; which is no other than a vast bundle of spirals: showing that the muscle in contraction should be short and thick; while upon the other hand, in relaxation it should be long and thin (compare  $\alpha$  and  $\beta$  in fig. 66).

52. A flattening of “segments” or “particles” in the contraction of muscle†, therefore, seems not to be required: and indeed I have in no instance met with segments or particles, which could undergo this change in form. But fig. 66. affords proof that the change contended for really takes place; this figure exhibiting the appearance of two parts of the same fasciculus, that were actually seen; the one,  $\alpha$ , being in a contracted, and the other,  $\beta$ , in a relaxed state: and the difference between these two conditions, was seen to result from a difference in the direction of the spirals. At one part,  $\alpha$ , the fasciculus being shortened, the spaces (striæ) between the curves of the spirals were made smaller, and the fasciculus was thick. At the part  $\beta$ , the fasciculus being lengthened, the spaces (striæ) between the curves of the spirals were made greater, and the fasciculus was thin.

53. The edges of the flat filaments (“fibrillæ”) in voluntary muscle being directed towards the observer, the flat surfaces of these filaments are in contact with one another (except where *septa* intervene, par. 42). And those parts of the spirals of two filaments, so in contact, fit together with the most perfect exactness and regularity, appearing to overlap one another, as viewed *in situ*. The adjacent parts of spirals thus glide harmoniously into a change of place. It will be seen that the view of a recent author, in regard to “segments,” was of this kind; but then he found it needful to suppose adhesion of the segments in some way to one another‡. And he appears to have figured as bead-like segments§, what I consider the overlapping parts of spiral threads.

53½. Many of the drawings that accompany the memoir (figs. 58, 59, 65, 93—95) show that there are states of voluntary muscle, in which the longitudinal filaments (“fibrillæ”) take no part in producing the transverse striæ; these striæ being caused by the windings of spirals, within which very minute bundles of longitudinal filaments are contained and have their origin. The spirals are interlaced (fig. 64  $\alpha, \beta, \gamma$ ). When mature, they are flat and grooved filaments, having the compound structure above described. With the shortening of the longitudinal filaments (“fibrillæ”) in muscular contraction, the surrounding spirals—and of course the striæ—become elongated and narrow: while in relaxation, these changes are reversed. The “convoluted filaments” regarded by GERBER as “enigmatical||,” were evidently no other than distorted spirals¶.

54. The spiral form of the ultimate threads of muscle, above described, will I think elucidate several facts already known, but as it appears to me, not satisfactorily explained. Thus, for instance, combined as I find these spiral threads of muscle, and situated one within the other, there cannot well be much difference in their lengths, when the fasciculus is broken off. Hence in part, probably, it is that the fasciculus

† BOWMAN, *l. c.*, pp. 493, 494.

‡ *Ibid. l. c.*, p. 470.

§ *L. c.*, fig. 10 *b, c*, fig. 11.

|| “Elements of the General and Minute Anatomy of Man and the Mammalia.” Fig. 83. Explanation of the Plates, p. 35.

¶ This paragraph was communicated to the Society as a Postscript, Jan. 11, 1842.

usually breaks off short. The membranous partitions or *septa*, above described (par. 42), no doubt contribute to prevent a difference in length. Besides which, fig. 123. shows that there are states in which the flat filaments ("fibrillæ") are shared by more than one surrounding spiral. See the additional observations, par. 119. I would also suggest that the spiral form of the ultimate threads of muscle, shows why it is that, before being broken off, the fasciculus sometimes becomes tapered to a point. An instance of this kind is to be seen in fig. 67, representing two portions of the same fasciculus. In  $\alpha$ , the direction of the curves of the spirals is comparatively transverse; and this part of the fasciculus is thick: in  $\beta$ , the direction of the curves becomes more and more oblique, until the fasciculus, rendered in the same proportion thin, terminates at last in a point. A very distensible membrane invests the fasciculus to the extremity; being one of the means by which its spiral contents are held together, during this violent elongation.

55. In a former paper†, I stated that membranes appeared to arise from the coalescence of discs. Fully confirming this observation, I have now to add, that, in some instances at least, the discs first form flat filaments, such as those above described; which filaments become interlaced with other filaments, divide, subdivide, and coalesce to form the membranes. The cellular tissue entering into the formation of the sheath of the spinal chord, we saw to become interlaced for this purpose‡: and in an earlier series of investigations, I found the incipient chorion to present an appearance somewhat the same§. The present memoir contains examples of membrane being formed out of interlacing filaments. Muscle presents an instance of membrane, that of the fasciculus, forming by the interlacement of mere spiral *threads*, many of which are too minute to admit of their structure being investigated. But the larger of these threads present a compound structure (figs. 125, 68), which admits of being traced into the objects I have termed flat filaments: and minuteness is no hindrance to the smallest undergoing a like change. The origin of this membrane out of spirals, may assist to account for its remarkable distensibility, elasticity, and toughness, pointed out by BOWMAN. This author indeed remarks, concerning it, that though from its minuteness and transparency, "it is difficult to form any decided opinion as to its structure \*\*\* it would seem not improbably to consist of a very close and intricate interweaving of threads far too minute for separate recognition." But he adds, that "the matter is very doubtful||."

56. In the mammiferous ovum, we saw the first cells succeeding the germinal vesicle to be few and large; and that there occurred a doubling of their number with every diminution in their size¶. The same process, essentially, we have since found

† Philosophical Transactions, 1841, pp. 209, 230, 243.

‡ Ibid., 1841, Plate XXII. fig. 116.

§ Ibid., 1840, Plate XXVIII. fig. 252.

|| *L. c.*, p. 478.

¶ Philosophical Transactions, 1840, p. 539.

to be in operation in the blood-corpuscule at certain periods†, and in tables of the epithelium‡. To meet with a re-appearance of anything like this process, however, in spiral fibres, I was not prepared. Yet here also, something of the kind is actually seen. For, as above described, within the space circumscribed by the windings of a larger spiral, there arise smaller ones, which are sometimes two in number. There is, besides, another way in which the process just referred to re-appears. A spiral, originally single, gives origin to others in the interior of its *substance* (fig. 71), and thus, by division and subdivision, gradually acquires considerable breadth (fig. 69), or there may be thus formed several separated spirals (figs. 73, 113  $\alpha$ ).

57. It will be seen, from the account above given of the formation of the muscular fasciculus, that the young fasciculi have the largest and fewest spirals. In the very young Tadpole, I found a great many fasciculi of this kind: while in the older Tadpole, such fasciculi were less numerous. The fasciculi here presented, generally, an increased number of spirals, with a diminution in their size.

58. I cannot doubt that the larger spirals perform contraction, as well as the smaller. It is probable that the difference between the contractile force of muscles in childhood and in adult age, is connected with the above-mentioned difference in the number of the spirals. Nor is this supposition inconsistent with the fact, that muscle by constant exercise increases in its bulk.

59. My observations on the form of the ultimate threads in voluntary muscle, first made on the larva of a Batrachian Reptile, have been confirmed by an examination of this structure in each class of vertebrated animals, including the scaled Amphibia, and Cartilaginous as well as Osseous Fishes. Such of the Invertebrata, also, as happened to be easily obtainable, were examined, and afforded ample confirmation of those observations. They included animals in the *Crustacea* (Crab), *Mollusca* (Limpet, Clam, Cockle, Mussel, Garden Snail, Periwinkle, Whelk), *Annelida* (Earthworm), and *Insecta* (a kind of Caterpillar).

*Facts observed in the Formation and Structure of the Crystalline Lens.*

60. In the Philosophical Transactions for 1841 §, I delineated cells, first arranged, like the beads of a necklace, in a line; and then, by the disappearance of the intervening *septa*, forming a tube, the foundation of the fibres of the Crystalline Lens||.

61. I have now to state, that within this tube there are formed, in the first place discs (fig. 129), and then filaments (fig. 130  $\alpha$ ), having precisely the same structure as the filaments of other parts. Nowhere have I obtained more satisfactory evidence, than in the lens, that these filaments are composed of two spiral threads (fig. 131  $\beta$ ,  $\gamma$ ), and that the spirals give origin within their winds to other filaments.

62. The toothed fibre discovered by Sir DAVID BREWSTER in the lens¶, is formed

† Philosophical Transactions, 1841, p. 204.

‡ Ibid., 1841, pp. 223, 224.

§ Plate XXV. figs. 157, 158.

|| I find that this observation was previously made by VALENTIN. See WAGNER's Physiologie: erste Abtheilung, p. 138.

¶ Philosophical Transactions, 1833.

out of an enlarged filament; the projecting portions of the spiral threads in the filament, that is, the apparent segments, becoming the teeth of that fibre. And here it is important to refer to a remark made in a former page (par. 16), that the filament has a tendency to become membranous at the surface, and that it contains within itself the elements of other filaments: both of which qualities may be recognized, as the filament is passing into the toothed fibre.

63. From my observations on vegetable structure, to be presently referred to (par. 68), I venture to anticipate that the toothed fibre noticed by SCHWANN in the epidermis of a Grass, and considered by him as corresponding to that of BREWSTER in the lens, will be found to have the same mode of origin.

*Facts observed in the Structure of Blood-vessels, Mould, Woody Fibre, Hair, Feathers, &c.*

64. In examining the coats of a large blood-vessel, I had noticed the filaments of one stratum to cross those of another stratum at right angles. But what was my surprise, when subsequently directing my attention to the structure of the arachnoid, at the remarkable display of filaments in the vessels of the pia mater (fig. 16.)! There are few parts in which the flat and compound filaments ("fibres"), so constantly mentioned in this memoir, are more easily or more distinctly seen, than here. The coats of such of these vessels as are empty, or nearly so, present an inner stratum of filaments having a longitudinal direction, and an outer filament spirally crossing these. In the coats of such of these vessels as are full, the outer or spirally directed filament is wanting. Vessels with the same structure are met with, having many times the diameter of the largest of those in fig. 16.

65. I saw in the olfactory nerve, blood-vessels having two sets of filaments such as those now described, as existing in the pia mater; and their diameter so small, as to admit the blood-corpuscles in only a single row. It is deserving of remark, that the corpuscles observed in this row, presented indications of division into corpuscles of minuter size.

66. We thus find blood-vessels, the walls of which consist of filaments, having the same structure as those filaments which the blood-corpuscle forms. In connection with the spiral direction of the outer filament in these vessels (fig. 16  $\beta$ ), as well indeed as with many facts recorded in this memoir, I refer to the *rouleaux* in which the blood-corpuscles are seen in the microscope to arrange themselves, as probably indicating a tendency to produce spiral filaments. To form *rouleaux*, corpuscle joins itself to corpuscle, that is to say, ring to ring, and rings, as we have seen (par. 34), pass into coils. The union of such coils, end to end, would form a spiral. But the formation, by the blood-corpuscles, of these *rouleaux*, is no less interesting in connection with facts recorded in a former memoir; namely, that structures, including blood-vessels, may be seen to have their origin in rows of cells derived from corpuscles of the blood.

67. I have noticed very curious resemblances in mould, arising from the decay of



organic matter, to early stages in the formation of the most elaborate animal tissues, more particularly nerve and muscle. Of such mould, figs. 25, 26, 34, 78, 97, and 104 may serve as examples. They present, it will be seen, mould from a ripe berry, and from decomposing animal substances, including cheese. Some of these figures (figs. 25, 26  $\beta$   $\beta$ ) represent cells, which have applied themselves to one another, and elongated; in one (fig. 26  $\gamma$ ), discs have arranged themselves in rows; in another (fig. 25), interlacing spirals have formed (out of discs); in a third (fig. 26  $\delta$ ,  $\epsilon$ ), there are seen rings; in a fourth (fig. 26  $\zeta$ ), spiral filaments have been produced, and become elongated; and in a fifth (fig. 78), a bundle of longitudinal filaments is surrounded by one having a spiral form. The plates present very similar appearances, observed in the most important structures of the animal economy.

68. Flax has afforded most satisfactory evidence of identity, not only in structure, but in the mode of reproduction, between animal and vegetable "fibre." We here find the same division of filaments into minuter filaments, and these again into filaments still more minute: as in fig. 76  $\alpha$ ,  $\beta$ ,  $\gamma$ ,  $\delta$ —states which were noticed in the same fasciculus of flax. There is also seen the same coalescence of some spirals, to form an investing membrane (figs. 109, 110) as is observable in muscle, while others retain the spiral form, and undergo the same division (fig. 113  $\alpha$ ) and subdivision ( $\alpha$   $\alpha$ ). In flax, filaments are frequently met with running in opposite directions around the fasciculus, and forming knots (fig. 101). Some of the flax-fasciculi afford evidence of a continued origin of new spirals in the same centre, after a considerable size has been attained (figs. 109, 110); these spirals being curiously interlaced.—See the description of figs. 109, 110. Very similar appearances, we have seen in nerve (par. 28). All the filaments in flax now mentioned consist of spirals, connected in the manner above described (par. 14), as their mode of combination in animal tissues.

69. The difference in the degree of development exhibited by a flax-fasciculus in different parts, is sometimes very great. Thus the three conditions  $\alpha$ ,  $\beta$ ,  $\gamma$ , represented in fig. 75, were noticed in the same fasciculus of flax.

70. In cotton, I found appearances of the same kind as those observed in flax  $\dagger$ .

71. Hair (fig. 139) presents the same kind of longitudinal filaments, as well as spiral filaments; some of the latter appearing to be curiously interlaced, and others coalescing to enter into the formation of the investing membrane. Besides the hair, of which a sketch is given in the figure, I have examined that of the Bat, Mouse, Mole, Rabbit, Sheep, Hog, Horse, Polar Bear, and Elephant, as well as the hair of Man; finding in all instances the filaments in question.

$\dagger$  It is a little singular, that the flax above mentioned had been spun and woven into the linen cloth used for drying the strip of glass on which the objects lay when examined: portions of these flax-fasciculi detached from the cloth remaining adherent to the glass. I found compound filaments, such as those above described, even in paper, and in dry cork; in Leghorn grass, taken from a hat; in the cedar-wood of a pencil; and in hemp that had been twisted into twine.

72. Certain hairs of plants have presented these filaments with great distinctness. Such has been the case also with the pappus of the *Compositæ* (fig. 126). I have examined the pappus in the Sow Thistle, Common Groundsel, and the Dandelion. In the stinging hair of the Common Nettle (fig. 128), the filament is arranged in a manner connected probably with the properties of this hair: the filament, formed, as in other cases, of two spiral threads, being itself coiled spirally upon the inner surface of each hair.

73. I have rarely seen the filaments in question more distinctly than in feathers from the chick *in ovo*, incubated fifteen days. The quill extremity exhibited them of larger size than the shaft.

74. I recognize spiral threads in the feather-like objects from the wing of the Gnat and Butterfly (fig. 141). In the latter they give rise to both longitudinal and transverse striæ. They are largest at the middle part, near the quill: but it requires close attention, and a very good light, to discern them at all in these objects, so minute is their size, and so closely are they packed together.

75. As already stated (par. 16), many are the instances in which the microscope fails to detect more than a grooved filament; the originally crenate edge presenting an unbroken line. Such is often the case in the Spider's web. Yet here also, filaments composed in the above way, are to be discerned (figs. 142, 143). Tension renders the filaments of this web less distinct; or rather, relaxation makes them more so. Sometimes they are single (fig. 143); sometimes two, three, or a larger number (fig. 142), are combined. Knots are sometimes met with, as though a broken filament had undergone repair.

76. I wound on a strip of glass the cord which a spider was giving off as it descended, for the purpose of making its escape; and found this cord to consist of a single grooved filament, in which a crenate edge was no longer to be seen. It has been already stated, that in one kind of cartilage, I found the nucleus of the cell to present the same appearance as a ball of twine. No doubt it is by a provision somewhat similar, that the Spider is prepared for an emergency such as that now mentioned: and indeed for the formation of its web. This seems much more probable than that the filaments are manufactured at the time when used.

77. When we see a corpuscle enlarging and becoming filled, in one instance with epithelium-cylinders†; in another with objects having the appearance of fat-globules‡; in a third with rudimental ova§; in a fourth with the materials for bundles of spermatozoa||; in a fifth with columns of discs for the formation of nervous substance¶; in a sixth with like columns for the origin of muscle (figs. 28, 30); and in a seventh with similar columns for forming the mould of cheese (fig. 26 γ),

† Philosophical Transactions, 1841, Pl. XXI. fig. 94.

‡ Ibid. Pl. XXI. fig. 103.

§ Ibid. Pl. XXV. fig. 164.

¶ Ibid. Pl. XXV. figs. 160 to 162.

¶ Ibid. Pl. XXIII. fig. 125.

we cannot but be struck with the great uniformity in type in the earliest stages of formation, however widely different the structures ultimately formed.

78. On a late occasion †, I showed the foundation of the new being, in what are called the highest animals, to have the same structure as that of the simplest plant. We now find this uniformity in type to be recognizable at later periods. For, not only does every tissue seem to arise out of discs having all the same appearance, but the primary arrangement and early metamorphoses of these discs seem to be the same. We recognize the same combination of spiral threads in the mould of cheese, as in the brain of Man. How wonderful the fact, that out of materials so similar, structures should be formed endowed with properties so different!

79. I have had an opportunity of examining the spermatozoon from the epididymis of a person who died suddenly ‡. The large extremity appears to me to be a disc, the pellucid depression in which, corresponding apparently to the “sugient orifice” of some authors, is probably analogous to the source of new substance in other discs. Each of the two sides of the peripheral portion of the disc is extended into a thread: these two threads forming, by being twisted, the part usually designated as the tail; an appendage the office of which appears to be to “scull” along to its destination the essential part or disc, and *more particularly its pellucid centre*. The formation of the “tail,” as now described, out of two twisted threads, seems to explain the observation of R. WAGNER, who, in rare instances, met with the caudal part double (as I suppose, untwisted) at the end. The *caudal* portion of the spermatozoon in the Rabbit presented a similar structure.

*On the Structure and Mode of Increase of the Vegetable Spiral.—On the Reticulated Duct, Annular Duct, and Dotted Duct of Plants.*

80. Having added to spirals from the leaf-stalk of the strawberry, a spiritous solution of corrosive sublimate (par. 7), I soon discerned in their substance something like a compound structure. In about half an hour, the interior of these spirals presented the appearance at  $\alpha$  in fig. 71: that is to say, they were seen to contain two filaments, such as those above described. I therefore consider these spirals to be reproduced in the same manner as those of muscle (figs. 68 to 70 and 73) and of flax (fig. 113  $\alpha$ ,  $\alpha$ ), which I find to become double and quadruple by self-division.

81. It may be added, that, were the division of the spiral, or at least the separation, to be complete in some parts and not in others, the appearance would resemble that of what is called the “reticulated duct.” And the tendency (as it is supposed) of vegetable “fibre” to anastomosis, might be thus explained.

82. Rings have been mentioned (par. 34), as observed in animal structure; which rings divide, and pass into coils. Coils are met with (fig. 22  $\beta$ ) that are equidistant,

† Philosophical Transactions, 1839, p. 372.

‡ For which I am indebted to the kindness of my friend ROBERT H. COOKE of Stoke Newington.

and in a line. It appears to be by the union of the adjacent extremities of coils, that there is produced the spiral (see the same figure). Corresponding rings and coils in plants, I have not seen nor sought for: but, with so perfect an analogy before me as that above described, I do not find it easy to believe that they can be deficient there. Now were such rings not to form coils, nor even to divide, but simply to enlarge, a line of them, equidistant within a tube, would have very much the same appearance as the "annular duct" of plants.

83. If the appearances delineated in figs. 87, 88, 89, 90, as noticed in the roots of a plant, be compared with those in fig. 25, from mould; in fig. 91, from the cornea of the eye; and in fig. 131, from the crystalline lens; as well as with figures of voluntary muscle in the lower line Plate VIII., and in other Plates, I think it will not be easy to refrain from believing the appearances in all to be produced by the same kind of structure. This structure, in such of the figures now mentioned as were previously referred to, we have seen to possess a spiral form. As already stated with reference to muscle (par. 42), spiral is formed within spiral; and the outer spirals more or less completely coalesce to form a membrane. The vegetable figure, fig. 90, seems to represent an advanced state of such as that in fig. 87. In both, as well as in fig. 88, spirals were observed within a tube. These spirals appeared to interlace with one another; and, by their close contact (fig. 90), to produce the appearance of transverse and elliptical "pores" or "dots." The apparent "dots" or "pores" I believe were no other than spaces between the winds of spirals, contained within a tube. Now spirals *interlacing* in the above way (figs. 87, 88, 90) must, by a longitudinal succession of their winds, produce *septa* (fig. 90  $\alpha$ ) in the containing tube. I cannot help believing that these observations will assist to solve the still undecided question, as to the structure of the "dotted duct." In short, I find it difficult to refer the appearance of the "dotted duct" to any cause but that above described, as producing the striæ in voluntary muscle (par. 53½).

84. The filaments in plants have often appeared to me to be so placed, that, by alternate contraction and relaxation, they might influence the contents of cells. And surely the structure of these filaments is sufficient to induce the belief, that they perform an important office in the circulation, including the elevation of the sap. An office of this kind may perhaps belong to spirals in the roots, and elsewhere, such as those in figs. 87 to 90; exhibiting, as some of these do, almost transverse striæ, like those of voluntary muscle in animals.

85. A structure presenting the same appearance as that of the essential part of muscle, being found to pervade, it may be said, all other tissues, it is evident that this structure alone does not account for the contractile property of muscle. To what then is the contractile property of muscle owing? This inquiry my observations do not enable me to answer. It is the duty of an investigator to record the facts he

meets with ; difficult as they may be to account for, or even paradoxical as at times they may appear.

86. It seems probable, however, that to the *spiral* structure of the filament ("fibre"), we may attribute the elastic and resilient qualities of certain parts ; such as elastic tissue, and cellular tissue, as existing in and under the cutis, and in the parenchyma of the lungs ; the latter being intimately connected with the question, whether the lungs are resilient in expiration.

87. Other parts in which the filament is found, as for instance some portions of the cutis, are capable of becoming *constricted*. The existence of filaments may be connected with that constriction.

88. There is, however, one structure in which I have met with the filaments in question, that possesses neither elasticity nor resiliency, nor the property of undergoing either contraction or constriction,—bone. This objection I have not the means of answering : but may be permitted to remark, that although its original developement (the formation of its cartilaginous state) is after the same type, its completion, for a special purpose, is effected by the addition of bone earth.

*Analogy between the Tissues of Animals and Plants, after (as well as before) their Formation is complete.*

89. The remarkable uniformity in structure between the elements of animal and vegetable tissues, pointed out by SCHWANN, I showed in the Philosophical Transactions for 1840, to begin with the first foundation of the new being. It will now be seen, I think, from the foregoing observations, that a degree of this analogy between animals and plants exists, not merely in the elements of their tissues, but after the formation of the tissues is complete.

90. That the nucleus of the vegetable cell, instead of being "absorbed as useless," after the formation of the cell-membrane, performs a part not less important than that which I have described as appertaining to it in animals, there can be no kind of doubt. I happen to have incidentally met with the germinal granules of the mushroom (fig. 27), and of the mould of cheese (fig. 26) ; and have figured them, as presenting evidence of this kind. Too much importance, it appears to me, has been attached, of late, to the *membrane* of the cell ; while the source of the contents of the cell, and apparently of all "secondary deposits," that is, the *nucleus*, has been overlooked.

91. It is stated by VALENTIN that in plants, all "secondary deposits" take place in spiral lines. I have already remarked, that in animals, spirals have heretofore appeared almost wanting. Should the facts recorded in this memoir, however, be established by the researches of other investigators, the question in future may perhaps be, where is the "secondary deposit" in animal structure, which is *not* connected with the spiral form ? But more than this : the spiral in animals, as we have seen, is in strictness not a "secondary" formation ; it is the most *primary* of all. And the question now, is whether it is not precisely so in plants.

*Additional Observations.*

Received April 27,—Read May 5, 1842.

92. I have the satisfaction of stating that since the foregoing memoir was presented to the Society, many gentlemen have afforded me the opportunity of demonstrating to them, either with my own microscope, or with instruments made by POWELL, ROSS, or SMITH, the leading facts recorded in it. To one of them (the son of an eminent physiologist, Dr. BOSTOCK) I am indebted for sketches of some of the appearances he saw. Two of these (figs. 145, 146) represent the filament within blood-discs: another (fig. 144) shows a similar filament constituting the muscular fibril. At  $\alpha$ , this filament is on its edge: at  $\beta$ , it presents its flat surface. What gives peculiar value to these sketches, is that they were made by one who then for the first time saw the objects in question.

*Facts observed in the Coagulation of the Blood.*

93. In the examination of coagulating blood, discs are seen having two very different appearances: the one kind comparatively pale, the other very red. It is the latter discs in which a filament is to be found, and which enter into the formation of the clot: the former being merely entangled in it, or remaining in the serum. Observers having directed their attention almost exclusively to the undeveloped discs so remaining in the serum, it is not surprising that they did not discern the filament in question: or that they supposed the blood-discs to be of subordinate importance, and to have no concern in the evolution of the fibrin.

94. In order to see distinctly the filament within blood-discs, some chemical reagent should be added, that will remove a portion of the red colouring matter, without dissolving the filament itself. I have employed for this purpose either the substance before mentioned (corrosive sublimate par. 7), or chromic acid<sup>†</sup>, or nitrate of silver<sup>‡</sup>,—and chiefly the last.

95. An objection has been taken to the employment of chemical reagents. It may be replied (as suggested by my brother JOHN T. BARRY),—if the point to be proved by the use of chemical reagents had been, that there exists *no visible structure*, then the use of those reagents would have been objectionable, because of their known destructive tendency in a concentrated state. As, however, the point to be proved is, that *a peculiar structure does exist*, it is not too much to assume, that the appearance of a structure so remarkable could not possibly be produced by the chemical action of one of those reagents, the mercurial compound for instance, when it is also

† Sp. gr. about 1.040.

‡ A solution consisting of 1 part nitrate silver in 120 water.

shown that the same structure is rendered visible by other reagents; such as the compounds of silver, and of chrome. It is singular that the objection to the use of chemical reagents should have been mooted by parties in the habit of employing maceration, a process of course highly destructive when prolonged for many days.

96. But the filament may be discerned without any addition whatever, if the coagulation has begun, provided its appearance has become familiar to the eye. In the blood of the Newt when so viewed (i. e. without any addition) the discs containing filaments often resemble flask-like vesicles (fig. 149). The membrane of most of the little flasks exhibits folds or creases ( $\beta$ ), converging towards the extremity of the neck. If this extremity is very carefully examined, it is often found that there is a small body protruding ( $\gamma$ ): this is no other than the extremity of the filament in question. It is now sometimes possible to discern that the folds just mentioned, mark the situation of the filament within the flask ( $\delta$ ). Occasionally a portion of the filament protrudes, sufficient to admit of its remarkable structure (par. 6) being seen. Sometimes the neck of the flask is bent ( $\beta$ ); so that, with the filament, there is produced the appearance of a comma. Still, as before said, for a complete examination of coagulating blood, it is advisable to remove a portion of the red colouring matter by some chemical reagent †.

97. There is considerable variety in the appearance of the red portion of the clot. In that of various Mammals, I have seen the following objects: namely, 1. parent cells ‡ (fig. 148  $\alpha$ ) filled with young corpuscles, resembling Ammonites; 2. groups of young corpuscles ( $\beta$ ), each of which was unwinding into a filament, and comparable to a Turrilite in form; 3. similar objects of larger size ( $\gamma$ ), also in groups, as if discharged from parent cells; 4. spiral *fasciculi* of filaments ( $\delta$ ), such as would be produced by the continued elongation and self-division which is represented as incipient in the corpuscles at  $\gamma$ . In other instances, the fasciculus of filaments has seemed to arise directly out of a parent cell; by the simultaneous metamorphosis, into filaments, of all the contained blood-discs.

98. The undulations to be observed in the filaments of “cellular” tissue, seem re-

† When first endeavouring to find the filament in question, the observer should use the clot in blood of the Frog or Newt, three or four hours drawn. Having placed upon a strip of glass a drop of the solution of nitrate of silver, introduce into it a portion of this clot; and with needles break the same into very minute parts; cover these with a piece of thinner glass; press the two glasses firmly together; and view with a power of 400 or 500 diameters. To find the little flasks above described, proceed in the same manner, and use the same clot, but without adding any chemical reagent. Blood (of one of the same animals) should then be examined, first with, and then without chemical reagents, just before its coagulation: and subsequently at various periods during the formation of the clot. I generally employ the Newt (*Lissotriton punctatus* of BELL): and obtain the blood by touching a strip of glass with the part from which the head has been removed; immediately adding a drop of the solution of nitrate of silver, and then a piece of thinner glass. This is done at the end of half a minute, and repeated in one minute, &c. for two or three minutes. The first perceptible changes in coagulation may be thus observed.

‡ These parent cells, usually elliptical, measured in length from  $\frac{1}{200}'''$  to  $\frac{1}{30}'''$  (Paris line), and were met with even of a larger size. Their colour blood-red.

ferable to a spiral mode of origin, similar to that producing the fasciculus of filaments in the clot fig. 148  $\delta$ . And the formation of spirals out of discs in the clot of blood resembles in a striking manner that described in the foregoing memoir, as witnessed in the formation of certain tissues: for instance, nerve and muscle. I have just mentioned the reproduction of filaments by self-division (fig. 148  $\gamma$ ,  $\delta$ ) as noticed in the clot: a process obviously the same as that described in the memoir as observed in the tissues. But the analogy does not end here. In a former communication<sup>†</sup> I figured blood-corpuscles (cells) from which the contents, except the nucleus, had been removed by acetic acid. If those figures be referred to, it will be found that the nucleus so remaining is in many instances *double*. An examination of coagulating blood enables me now to offer some explanation of this curious fact.

99. In fig. 150 is sketched a blood-corpuscle (cell) presenting a coiled filament,  $\alpha$ . This coil having arisen out of the nucleus of the corpuscle or cell, the residual portion of the nucleus became double by self-division: and then each half of the nucleus formed a coil, so that an outer coil contained two smaller coils ( $\beta$ ,  $\beta$ ), each having a pellucid centre for future change. We here again find a process in operation, bearing a striking resemblance to that producing tissues.—Compare with fig. 147.

100. Where the supply of nutriment goes on, this process of self-division, and the formation of new solid substance, are continued until an entire tissue is produced. Where that supply is soon exhausted, as in coagulating blood, the process in question is speedily at an end. But here also, as in the tissues, greater firmness is acquired as new substance forms. When the supply of nutriment is exhausted, there is no longer a renovation of the nucleus: and now there is seen a cavity (fig. 152  $\alpha$ ). This appearance is very frequent in the advanced clot.

101. The best delineations I have met with of coagulated blood, are those by G. GULLIVER<sup>‡</sup>. They are to be explained, I believe, by the facts above mentioned: as well as those given by the same observer of morbid growths<sup>§</sup>; which, like healthy tissues, have their origin in corpuscles of the blood||.

102. In the blood-clot, corpuscles are seen of a much minuter size than those usually circulating in the animal. Such corpuscles are constantly met with in the clot of the Frog and Newt. They owe their origin to previous corpuscles; a filament is often to be seen within them; they are frequently membranous at the surface; more or less spherical in form; and generally of a deep red colour.

103. In a former paper, when describing the origin of the various structures of the body in corpuscles of the blood, I mentioned having noticed a reproduction of red

<sup>†</sup> Philosophical Transactions, 1841, Part II. p. 201. Plate XVIII.

<sup>‡</sup> In GERBER'S "Elements of the General and Minute Anatomy of Man and the Mammalia," Pl. XXVIII.

<sup>§</sup> Ibid. Plates XXIX. XXXI.

|| Dr. HODGKIN informs me that in some perfectly recent cancerous matter which contained particles in many respects resembling those of the blood of reptiles, he saw great numbers of them having an unequivocal tail-like process appended to them, which was evidently formed from the material surrounding the nucleus.



colouring matter also. The evolution of red colouring matter forms one of the most remarkable changes in the coagulation of the blood (par. 93).

104. The prodigious rapidity with which filaments form during the coagulation of the blood, will be obvious from the short space of time occupied by this process; of which the production of these filaments seems to constitute the leading part.

105. The “notched or granulated fibres” observed by Professor MAYER in the blood†, were possibly my flat, grooved, and compound filaments, a particular description of which has been given in the above memoir; but if so, there is this important difference between the opinion of Professor MAYER and my observations as to their mode of origin. He regards them as representing “free fibrin in the blood,” and, from having seen more of them in inflammation, as perhaps the “mechanical consequence of an increased pressure of the blood, by the more rapid and forcible systole of the heart and arteries.” He even thinks it possible to produce the same appearances “by drawing the plasma of the chyle into a thread.” The filaments I have described are produced in neither of these ways; but, as we have seen, have their origin in corpuscles of the blood.

106. On former occasions‡, I have mentioned these corpuscles as sometimes exhibiting changes in their form. When last referring to this phenomenon, I expressed my conviction that it arose from an inherent contractile power; an idea which repeated observation has confirmed, and which has been strengthened by the very decided opinion of several gentlemen to whom I have shown the phenomenon in question. As I had noticed such an inherent contractile property in blood-corpuscles, it was very interesting to me to meet with moving filaments in some blood from the heart, that had stood for a day or two after death§. And I have since had the further satisfaction to find that the fibres just referred to as seen by Professor MAYER were observed by him in the Lamprey to present free and spontaneous motions.

107. We are indebted to W. ADDISON|| for the discovery of an immense number of “colourless globules,” sometimes observable in the clear colourless fluid at the top of coagulating blood. I have had the opportunity of examining blood presenting, in its coagulation, a top-stratum of clear, nearly colourless fluid; and what I regarded as the “globules” in question. In some blood taken in Pleuritis, I found the number of such “globules” prodigious. They obviously contained discs, the outer of which disappeared on the addition of acetic acid (of the strength of distilled vinegar): and I was not a little interested on finding the residual contents to present the same ap-

† FROBIEP's Notizen, No. 377, April 1841, p. 42.

‡ Philosophical Transactions, 1840, Part II. p. 598; 1841, Part II. p. 227.

§ The appearance of some of the blood-corpuscles when performing the movements in question, is such as to suggest the idea of a filament being contained within them.

|| “On colourless globules in the buffy coat of the Blood,” Lond. Med. Gaz., 1840, vol. xxvii.

pearances as some of those figured in one of my former communications to the Society, as resulting from the addition of this reagent to corpuscles of the blood†. It immediately became a question with me, whether some of the appearances so delineated were not those of "colourless globules;" a few of which, it is known, are seen floating along with the red discs. I therefore attentively examined blood-corpuscles in very large number, without having added any chemical reagent: and the result is, that I believe the colourless globules, floating with the red blood-discs, to be no other than these discs in an altered state‡. The colourless globules appear to represent different stages in the formation of *parent cells*, which in a former memoir I showed to have their origin in red blood-discs.

108. Acetic acid, then, produced such a change in the colourless globules at the top of the coagulating blood just mentioned, that I believe them to have been of the same kind as certain corpuscles usually floating in the blood: corpuscles paler than the rest, and termed "colourless globules."

109. Are any of the colourless globules in the top-stratum of coagulating blood concerned in producing the buffy coat? ADDISON believes that they "coalesce" to form it. "In a few minutes," says he, "coagulation commenced in streaks and films, all of which were evidently composed by the aggregation of the globules." The optical instrument used by ADDISON was merely a CODDINGTON lens: but the employment of a compound microscope, with very high magnifying powers, has not enabled me to detect any other substance than the globules he pointed out, with the containing fluid, as giving origin to the buffy coat. The fact is, that the globules I met with were no other than *parent cells*, more or less advanced in producing young blood-discs. In the top-stratum I met with a number of these young discs, discharged from their cells, very minute and delicate, and scarcely tinged with red. When the top-stratum had coagulated, these cells were no longer found: but in their stead I saw fibres, such as those in tissues, known to have their origin in cells: not in the cell-membranes, which I find to be of very subordinate importance (par. 90), but in the discs contained within the cells. These fibres were certainly not produced by manipulation§. Among the fibres, nuclei were met with, resembling those in the tissues, which, according to my observations, are descended by fissiparous generation from the nuclei of the original cells (par. 19). In some parts these nuclei were

† Which, I should now add, were obtained by punctures of the finger. See Philosophical Transactions, 1841, Part II. Plate XVII. fig. 23.

‡ The figure just referred to, indeed, represents stages in this transition. See the description of that figure. Thus  $\eta$  had ceased to be biconcave, and become globular: but the nucleus was indistinctly seen, from the surrounding discs and *red colouring matter* having been imperfectly dissolved. Most of the objects there delineated represent *cells*, such as before the addition of acetic acid are filled with discs; only the last formed of which remain visible after the addition of the acid.

§ In a paper of later date than those above referred to, W. ADDISON describes the macerated clot as containing "fibres and filaments, having the toughness, cohesion, and elasticity of organized membrane." Lond. Med. Gaz., March 26, 1841, p. 14. This I fully confirm, from many observations.

less obvious: but I noticed in the same situations minute threads of a spiral form, and am inclined to think that they were the nuclei in an altered state.

110. It is gratifying to me to find in the observations of Dr. REMAK† a confirmation of one previously communicated to the Royal Society by myself (and realizing an idea of Professor OWEN), viz. the reproduction of the blood-corpuscles by means of parent cells‡.

111. Farther, the observations of REMAK led him to believe that the blood-corpuscles of the foetal chick of the third week are propagated by “*division*.” I must here add, that division of the *nucleus* is what I have been long indicating as the mode of reproduction, not only of blood-corpuscles, but of all other cells.

112. It remains to be seen whether my further observation also, that the parent cells are altered red blood-discs, will not be confirmed.

113. According to Dr. HANNOVER, the pale central fibre or primitive band has no concern in producing the varicosities of nervous fibre: and from the observations of Dr. REMAK, it appears that the pale sheath takes no part therein; but that it is the *opaque* sheath (“white substance”) that becomes varicose§. This accords with my view (par. 39), that the varicosities result from a rupture in many parts, and a recoiling, of the remarkable filaments of which (according to my observations) the “white substance” is composed||.

114. Since the foregoing memoir was presented to the Society, I have seen the remarkable filaments therein described (par. 6) in “false membrane,” in the horny tissue of the hoof, in the chorion and amnion of one of the Mammalia, and in the chalazæ of the Bird’s egg. The latter consisted entirely of them.

115. It has long appeared to me questionable, whether the generally received opinion is correct, that the chalazæ consist merely of coagulated albumen to which a spiral form has been given by revolutions of the ovum in its passage through the ovi-

† British and Foreign Medical Review, January, 1842, p. 229. From the Medicinische Zeitung, Juli 7, 1841.

‡ My paper, recording the above observation, was read January 14, 1841. See Philosophical Transactions, 1841, Part II. p. 201. figs. 39, 41  $\gamma$ , 45  $\alpha$ , 53  $\beta$ .

§ MÜLLER’S Archiv, 1841, p. 512.

|| A friend has pointed out to me a figure by FONTANA, which I am glad to have the opportunity of noticing while the paper is going through the press. It shows, I think, that this observer, sixty years since, discerned traces of the filaments of which I find the “white substance” to be composed. He describes a primitive nervous cylinder as appearing to have “ça et là sur les parois quelques fragmens de fils tortueux.” (Traité sur le Vénin de la Vipère, Tab. IV. fig. 1. p. 279.)

Another friend has pointed out to me in a recent work by VALENTIN, that has just come into his hands (SAMUEL THOMAS VON SÖMMERING, Hirn-und Nervenlehre), a passage which, so far as it goes, agrees with an observation recorded in the foregoing memoir, namely, the formation of membrane out of spiral fibres (pars. 42, 55). VALENTIN states that, under favourable circumstances, it is possible to discern that the delicate membrane surrounding the contents of the nerves is formed of fibres; two of which he describes as appearing to run screw-like around the tube. *L. c.*, p. 5, § 8.

duct. And the observation now recorded, that these structures consist of the remarkable filaments in question, seems sufficient of itself to warrant the belief that they have no such mode of origin.

116. I have already mentioned having seen these filaments in the shell-membrane of the Bird's egg. This membrane I believe is usually regarded as the analogue of the chorion in Mammalia. Now the chorion of the Mammal, according to my observations, has its origin in corpuscles of the blood: and it is not likely that its analogue in the Bird is produced in a different way.

117. On a former occasion †, we saw the incipient chorion, when rising from the "zona pellucida" in the mammiferous ovum, to leave a stratum of unappropriated cells behind it on the "zona," a gelatinous fluid intervening. These cells are subsequently appropriated in the thickening of the chorion. I think it possible that it may be the outer layer of the chorion just mentioned, that is represented by the shell-membrane; while the stratum of cells left for a while on the "zona" in the mammiferous ovum, finds its analogue in the chalazæ of the Bird's egg. If so, it will doubtless be found that the chalazæ also have their origin in corpuscles of the blood; which indeed their structure renders probable.

118. As already mentioned (par. 53½), many of the figures which accompany the foregoing memoir represent states of voluntary muscle, in which the longitudinal "fibrillæ" have no concern in producing the transverse striæ. In these states, the transverse striæ are caused by comparatively large interlacing spirals, which dip inwards in a manner that may be represented by making the half-bent fingers of the two hands to alternate with one another, and then viewing them on the extensor side. The longitudinal "fibrillæ" are contained within the spaces circumscribed by the interlacing spirals.

119. It is in such states of voluntary muscle, that the fasciculus "breaks off short (fig. 157)." This breaking off short is a natural consequence of the interlacing of the spirals; as may be easily shown by a wire model, representing this state of the fasciculus. The fracture of course takes the direction in which there is the least resistance. This direction is the transverse, for in any other there would be a greater number of the curves of spirals to be encountered‡. Sometimes the fasciculus, instead of being "broken off short," is merely *notched* (fig. 157). These two effects of manipulation, however, differ only in degree; the cause producing both being the same§. *This seems to be the explanation of transverse "cleavage."*

† Supplementary Note to a Paper entitled "Researches in Embryology. Third Series: a Contribution to the Physiology of Cells." Philosophical Transactions, 1841, Part II. p. 193.

‡ When the *longitudinal* striæ are exceedingly distinct, the fasciculus does not "break off short." This appears to be owing to the absence now of the investing spirals; which, when present as such, regulate the direction of the fracture. I have already stated them to pass into a membranous form.

§ Occasionally the extremities of the ruptured spirals (figs. 156, 157) may be seen pendent at the part where the fasciculus is broken off or notched.

120. A late observer seems to have regarded the interlacing spirals, now mentioned, as "the edges or focal sections of plates or discs, arranged vertically to the course of the fasciculi, and each of which is made up of a single segment of every fibrilla-†." He seems to have mistaken the normal appearances of interlacing spirals, for disturbed states of his supposed "discs." The minute anatomy of the tissues is to be learnt in no other way than by tracing them from their earliest origin.

121. I have in no instance delineated muscle that had undergone maceration, a process open to objection, because putrefactive changes may cause the more delicate portions of a structure to disappear. Can the alleged "beaded" structure of the fibril (which I have never been able to see in *recent* muscle) be demonstrated *without* maceration?

122. This may not be an improper place to draw the attention of future observers, generally, to the effect produced by corrosive chemical reagents, as well as by maceration: whether the maceration be continued so as to produce putrefaction or not. It is easy to imagine that, owing to the operation of either of these, a delicate structure may be entirely destroyed, and therefore unrecognized; or its continuity separated into isolated parts. And I cannot but think that it must be from some such cause as this (the disintegrating effect of prolonged maceration), that BOWMAN exhibits the fibril of muscle as consisting of beads‡, while my own observations represent it as consisting of a double spiral: and that there is so great a difference between his explanation and my own, of transverse "cleavage." It is true that I also have had recourse to the use of chemical reagents. But there is a wide difference between *the presence* and *the absence* of a visible object immediately after the application of a chemical reagent, when the *peculiar form* of that object entitles it to be considered, not as a chemical compound, but as an organized structure (par. 95).

123. Observers appear not to have determined the mode in which the "fibres" contained in hairs have their origin§. Young hair (wool) of the foetal sheep presented to me the appearance, an outline of part of which is sketched in fig. 155. The hair-bulb contained nuclei, which seemed to be unwinding, watch-spring-like, into "fibres," that is, flat, grooved, and compound filaments ( $\alpha$ ), which I have already mentioned having seen in hair (par. 71). These filaments, immediately after being given off from the nuclei, appeared to *interlace*. In the shaft they presented very much the same appearance as those in the olfactory nerve (fig. 108). The interlacing of the filaments produces very remarkable appearances in the shaft of many hairs, as those of the Mouse, Mole, and Rabbit.

† BOWMAN, *l. c.*, p. 469.

‡ As in "three fragments of a macerated heart." BOWMAN, *l. c.*, Plate XVI. fig. 17.

§ See SIMON, in MÜLLER'S Archiv, 1841, Heft IV. p. 369: by whom the researches of HENLE, and those of BIDDER are referred to.

124. At the commencement of last year, I presented to the Society a communication, in which certain appearances I had noticed in blood-corpuscles were referred to a process of the same kind as that previously described by myself, as witnessed in the germinal vesicle, that is, in the essential part of the ovum. I concluded, that the corpuscles of the blood are generated by a process of the same kind as that giving origin to those cells which are the immediate successors of the germinal vesicle, or original parent cell. The comparison, however, was not then extended beyond the mode of production of young cells.

125. My subsequent researches show that we may go farther. The changes taking place in the ovum lead to the formation of a new being. Those effected in the corpuscle of the blood lead to the formation of a filament, endowed with the property of reproducing itself by division. And what is very remarkable, the position of this filament in the blood-corpuscle bears a striking resemblance to that of the young in the ovum of certain intestinal worms, as remarked by Professor OWEN, on seeing my drawings of the filament in corpuscles of the blood†. Is the blood-corpuscle to be regarded as an ovum?

#### 126. EXPLANATION OF THE PLATES.

##### PLATE V.

- Fig. 1. Man. Blood-corpuscles, in blood obtained by a puncture of the finger. Each of them has become a filament, having a coil-like form (par. 1).
- Fig. 2. Man. Blood-corpuscles, in blood (obtained by a puncture of the finger) which had stood for some time, between two pieces of glass, in the microscope. Each of them is now a more or less coiled filament. The division of the blood-corpuscle into very minute objects (discs), which may be seen taking place in the microscope, seems to be preparatory to the formation of the filament (par. 25).
- Fig. 3. Man. From the coagulum of venous blood, taken in hæmoptysis.  $\alpha$ . Filaments, for the most part parallel.  $\beta$ . Blood-corpuscle which has passed into a coiled filament (par. 8).
- Fig. 4. From the same coagulum.  $\alpha$ . Filaments;  $\beta$ . Rings;  $\gamma$ . Coils, and other objects; all of them altered blood-corpuscles, having the same structure as the filaments  $\alpha$ . The whole blood-red. The buffy coat in other blood presented similar filaments, in denser aggregation, and less red (pars. 8, 97).
- Fig. 5. Sparrow (*Fringilla domestica*, LINN.). Sketch of blood-corpuscles, each presenting a coiled filament. The figure represents the *structure* of the filament at  $\alpha$  (par. 13).

† I have already mentioned that the appearance of some of the blood-corpuscles when exhibiting changes in their form, is such as to suggest the idea of a filament being contained within them.

- Fig. 6. Sparrow. From the coagulum of blood.  $\alpha, \beta$ . Blood-corpuscles (coils) unwinding themselves into the straight and parallel filaments of the coagulum (par. 8). The filament  $\beta$  is on its edge (par. 6).
- Fig. 7. Chick (*Phasianus Gallus*, LINN.) *in ovo*, incubated twelve days. Sketch of blood-corpuscles (coils), which are unwinding themselves as filaments.  $\alpha$ . Parallel filaments, in the same field of view. Blood-red. From the wing. Similar objects seen in the leg (par. 8).
- Fig. 8. Turtle. Sketch of blood-corpuscles containing filaments. In all of these corpuscles, the filament is *formed* at the outer part. Between this outer part and the centre, the corpuscles  $\alpha, \beta$  present discs arranged in lines for the formation of a further portion of the filament (par. 25). In the coagulum of blood of the Turtle, the same unwinding of corpuscles into filaments was seen, as is described in the explanation of fig. 10. from the Newt, and in other figures.
- Fig. 9. Frog (*Rana temporaria*, LINN.). Sketch of blood-corpuscles containing filaments.  $\alpha$ . Even the central part is unwinding itself into a filament.  $\beta$ . Exhibits a spiral arrangement of the filament.  $\gamma$ . Filament on its edge at one part: indistinct at other parts in this corpuscle.  $\delta$ . Discs, also, seen in this corpuscle: their outer part having very much the appearance of a filament.
- Fig. 10. Newt (*Lissotriton punctatus*, BELL.). Sketch of blood-corpuscles containing filaments, which are represented only in certain parts.  $\alpha$ . The nucleus is double (pars. 98 $\frac{1}{2}$ , 99).  $\beta$ . The outer part of the nucleus resembles that of a ball of twine, from its consisting of a filament.  $\gamma$ . The nucleus unwinding itself into a filament.  $\delta$ . The filament on its edge (par. 6).  $\epsilon$ . Nucleus removed from its corpuscle. It is unwinding itself into a filament.  $\zeta$ . Corpuscle giving off a filament from its outer part.  $\eta$ . Filaments, some of them parallel, into which some of the corpuscles have passed. This blood had stood for a while in the microscope (par. 8).
- Fig. 11. Toad (*Rana Bufo*, LINN.). Sketch of blood-corpuscles containing filaments.  $\alpha$ . The coil-like form of the filament is seen.  $\beta$ . Represents the outer portion of the filament lying on its edge; and rendering this part of the corpuscle thicker than that immediately internal to it; as well as giving to the corpuscle the appearance of being abruptly cut off (par. 2).  $\gamma$ . In a condition less advanced than  $\alpha$ : there being in  $\gamma$  more of the central part still in the state of discs (par. 2).
- Fig. 12. Skate (*Raia batis*, LINN.). Sketch of blood-corpuscles, each containing a coiled filament. This filament on its edge at the circumference (see the explanation of  $\gamma$ , fig. 11 and par. 2).
- Fig. 13. Cod (*Gadus Morrhu*, LINN.). Sketch of blood-corpuscles more or less advanced in giving origin to filaments.  $\alpha$ . The formation of the filament is

far advanced;  $\beta$ . the outer part is formed, nucleus double (pars. 98 $\frac{1}{2}$ , 99);  $\gamma$ . no part of the filament yet formed; but discs are arranged in a line for its formation (par. 25).

Fig. 14. Lobster (*Cancer marinus*, LINN.). Sketch of blood-corpuscles, each of which has become a coiled filament (par. 4).  $\alpha$ . Structure of the filament (par. 6). At  $\beta$  the filament is on its edge.

Fig. 15. Oyster (*Ostrea edulis*, LINN.). Sketch of blood-corpuscles, each of which has become a coiled filament (par. 4). At certain parts the figure represents the structure of the filament (par. 6).

#### PLATE VI.

Fig. 16. Rabbit (*Lepus Cuniculus*, LINN.). Sketch of blood-vessels in the pia mater  $\alpha$ . Longitudinal filaments, merely dotted in, except that on the left, which represents the structure of the filament (par. 6).  $\beta$ . Outline of a filament spirally investing the longitudinal filaments.  $\gamma$ . Structure of this filament.  $\delta$ . Blood-corpuscles, chiefly young and of very minute size.  $\epsilon$ . Line marking the situation of the inner surface of the vessel (par. 64).

Fig. 17. Rabbit. From the spinal chord. Corpuscles, apparently young blood-corpuscles ( $\alpha$ ), passing into a compound disc ( $\beta$ ), out of which there is formed either a ring ( $\gamma$ ) or a coil ( $\delta$ ). The larger coils  $\epsilon, \epsilon$ , seemed to be advanced conditions of  $\gamma$  and  $\delta$ . Colour red (par. 34).

Fig. 18. Rabbit. Sketch of bodies observed in the retina. The general appearance of such bodies is that of rings, having a very high refractive power ("globules" of authors?). But they are coiled filaments, often seen to be formed out of rings such as those in fig. 17. Such objects are red (par. 34).

Fig. 19. Rabbit. From the medullary substance of the brain. Ring-like object or coil, connected, certainly at  $\alpha$  and probably at  $\beta$ , with a filament, the structure of which is seen at  $\gamma$ . Blood-red (par. 34).

Fig. 20. Sheep (*Ovis Aries*, LINN.). From the grey substance of the cerebellum. Sketch of coils, which are altered discs, such as  $\beta$  fig. 17 (par. 34).

Fig. 21. Sheep. From the spinal chord†. Coils, arisen out of discs having the appearance of blood-corpuscles.  $\alpha$  Was lying on  $\beta$ , and apparently entering, with it, into the formation of a tube (see pars. 34. 35).  $\gamma$ . Structure of the coiled filaments.

Fig. 22. Sheep. From the spinal chord†. Objects such as those in fig. 21 having united to form a tube ( $\alpha$ ), other spirals come into view in the interior (which indeed are represented in fig. 21). The continually renewed nuclei, unwinding themselves, first in one direction and then in the other, give origin to coils, the adjacent extremities of which unite, and then form

† White substance from the interspace between the posterior and lateral tracts.



spirals. The last formed, or forming, of these spirals is seen at  $\beta$ , together with its structure.  $\gamma$ . Represents the nuclei. Spirals were noticed between  $\alpha$  and  $\beta$ , but they are not represented in the figure (pars. 35, 38).

Fig. 23. Chick *in ovo*; twelfth (?) day of incubation. Sketch of a muscle-tube.  $\alpha$ . Membrane.  $\beta$ . Nuclei in the centre of the tube: very near together.  $\gamma$ . Spiral.  $\delta$ . Another spiral appearing to arise from some of the nuclei. See the description of fig. 22  $\beta$ .

Fig. 24. Rabbit. From the cortical substance of the cerebrum. Blood-red cell arranged to form tubes. These cells are in outline excepting two, in which the contents were seen to consist of discs, or ring-like objects, arranged with regularity, like those in muscle, fig. 45.

Fig. 25. Sketch of mould on a ripe berry (*Rubus fruticosus*, LINN.) that had been kept a few days. Cells having arranged themselves in a necklace-like form, have elongated, and spirals are forming in their interior (par. 67).

Fig. 26. Sketch of mould from cheese.  $\alpha$ . Granules, escaped from containing bags.  $\beta$ ,  $\beta$ . Tubes, still exhibiting the *septa* between the cells, by the union of which they were formed. One of them is branched. At  $\gamma$ , in one of the tubes, are cell-like objects arranging themselves in lines.  $\delta$ . Rings now visible.  $\epsilon$ . Smaller rings, or interlacing spirals.  $\zeta$ . Spirals having been formed, they have become very much elongated, so as to appear nearly horizontal (par. 67).

Fig. 27. Mushroom. Sketch of germinal granules, of a reddish brown or purple colour, from the hymenium. In such granules a nucleus is seen, often consisting of two parts. Around the nucleus are other objects, smaller and having a less refractive power. These are not represented, except in  $\alpha$ .  $\beta$ . Granule, apparently younger than the rest (see par. 90).

Fig. 28. Tadpole, about  $5'''$  or less. From the tail. Outline of cells, which are altered blood-corpuscles, arranged in a line to form the first muscle-cylinder or tube (par. 42).

Fig. 29. Tadpole, about  $5\frac{1}{2}'''$ . From the tail. Corpuscles having the appearance of young blood-corpuscles, as viewed along with many others in a group, apparently escaped together by the rupture of one parent corpuscle. Cells such as those in fig. 28 are filled with young corpuscles or discs, apparently of the kind represented in the present figure (par. 42).

Fig. 30. Tadpoles,  $4\frac{1}{2}'''$  to  $5'''$ . From the tail. Fragments consisting apparently of the contents of objects such as those in fig. 28; the discs (fig. 29) in which have arranged themselves in columns. The fragments are for the most part in outline, except  $\beta$ .  $\gamma$  Presented a membranous appearance at the surface, not seen in  $\alpha$  and  $\beta$ .  $\alpha$  Was of such length as to appear like two of the cells in fig. 28, not separated from one another.  $\delta$ . Appearance presented by one of the compound discs in the columns (par. 42).

- Fig. 31. Tadpole,  $4\frac{1}{2}'''$ . From the tail. Compound discs resembling those in figs. 29 and 30. The adjacent ones seemed to have united at a certain part, so as to produce a spiral form. The two bodies in this figure appear to be two columns such as those in fig. 30 (par. 42).
- Fig. 32. Tadpole,  $5'''$ . From the tail. Tubes the parietes of which consist of spirals, forming out of discs such as those in fig. 31 (par. 42).
- Fig. 33. Tadpole. From the tail. More advanced stage of the same kind of tubes (par. 42).
- Fig. 34. Mould, found on the left auricle of a sheep, several days dead. It is almost entirely in outline. The figure represents two parallel and contiguous tubes; each tube lined by what appeared to be smaller tubes. The divisions between the latter are shown by dots. Within the *larger* tubes, there were highly refracting globules (see the figure), varying much in size, and some of them, when first seen, were easily moved in the longitudinal direction of the tube. They probably were contained in a fluid. Within the smaller tubes on the left hand, were seen either rows of discs ( $\gamma$ ), or filaments ( $\beta$ ). The smaller tubes on the right hand ( $\alpha$ ) presented a central cavity; these being probably more advanced than the tubes at  $\beta$  and  $\gamma$ .

## PLATE VII.

*This Plate represents the Formation of Muscle.*

- Figs. 35 to 44. Chick *in ovo*; incubated twelve days. Early stages in the formation of muscle, from various parts of the body. Very much in outline.
- Fig. 35. There are seen parietal nuclei, with orifices in them: these orifices corresponding to the "nucleoli" of authors. At  $\alpha$ , the discs are arranging themselves in a spiral form even around the orifice, *i. e.* as soon as formed. A large spiral invests the whole.
- Fig. 36. The figure represents the central part of a tube ( $\alpha$ ) and a spiral ( $\beta$ ). At the outer part, in  $\alpha$ , are longitudinal filaments. The spiral  $\beta$  surrounded these filaments. The inner part of  $\alpha$  is occupied by cells. Each cell has a highly refracting nucleus, and is filled with discs. The nucleus in each cell has an orifice ("nucleolus").
- Fig. 37. Mere outline. The nuclei have positions different from those of the nuclei in fig. 36.
- Fig. 38. Some of the filaments contained in the tube present their edges, others their flat surfaces to the observer. In the middle of the tube there are nuclei, small and in near approximation. The tube is flat.
- Fig. 39.  $\alpha$ . Spiral filament.  $\beta$ . Longitudinal filament; parallel to which, are others of the same kind in outline.  $\gamma$ . Nucleus divided into several parts (discs).

- Fig. 40. More advanced state of apparently corresponding objects; the filaments enlarged.
- Fig. 41.  $\alpha$ . The points of contact in the spiral threads, which constitute the filament, beginning to separate.  $\beta$ . This separation more complete (par. 27).
- Fig. 42. Appearances, in three instances, of the nuclei in muscle-tube. The dots show merely the breadth of these tubes. We have here evidence of division ( $\alpha$ ) and subdivision ( $\beta$ ) of the nucleus, with a diminution in its size (par. 42). Filaments were very distinct in the tube  $\beta$ .
- Fig. 43. Sketch showing some displacement of filaments by the nucleus; and slight enlargement at this part in the breadth of the tube. It is the edges of the filaments that are seen in this figure.
- Fig. 44.  $\alpha$ . Nuclei and spirals contained in a tube.  $\beta$ . Another part of the *same tube*: its diameter greater; and this part filled with discs, the arrangement of which was regular (pars. 22, 42). These discs quite red, and resembling young blood-corpuscles (par. 42).
- Fig. 45. Chick *in ovo*; incubated twelve (?) days. Outline of the extremity of a muscle-tube, and its contents. These were discs, having precisely the same appearance as young blood-corpuscles (par. 42); and they were arranged with great regularity (pars. 22, 42) in the tube (see the explanation of fig. 48).
- Fig. 46. Tadpole,  $5\frac{1}{2}'''$ . From the tail. Muscle-tube containing discs having the same appearance as young blood-corpuscles (par. 42), each of which exhibited bright points near the centre, these denoting the situations of future discs (par. 44).
- Fig. 47. Turtle. Muscle-tube from the heart. The tube contains rings linked together, and preparing to form interlaced spirals (pars. 22, 42).
- Fig. 48. Tadpole,  $5\frac{1}{2}'''$ . Muscle-tube. From the tail.  $\alpha$ . Rings, arranged with great regularity in the same way as the discs in figs. 45 and 46.  $\beta$ . Structure of the rings.  $\gamma$ . Spirals formed out of such rings (pars. 22, 42).  $\delta$ . Structure of the spirals. Each ring appeared to contain the elements of future rings (par. 44), not represented in the figure.
- Fig. 49. Tadpole,  $5\frac{1}{2}'''$ . Muscle-tube, in which are seen interlacing spirals, each of which surrounded minuter objects (filaments?).
- Fig. 50. Tadpole, about  $5'''$ . Muscle-filament ("fibril") on its flat surface. It measured in breadth  $\frac{1}{1000}'''$  (par. 45).
- Fig. 51. Young Monoculus. Flat surface of a muscle-filament ("fibril"), observed in the leg, near its extremity (par. 45).
- Fig. 52. Turtle. From the heart. Muscle-filament ("fibril") on its flat surface (par. 45). At the lower part the two spiral threads composing it have become unconnected. One of these threads still presents the spiral form.

- Fig. 53. Chick *in ovo*; incubated fifteen days. From the leg. Filament, seen with an immense number of other filaments, forming a very large muscle-fasciculus (par. 45).
- Fig. 54. Periwinkle. Interlacing spirals. The lower part of  $\alpha$  was not very distinctly seen on the left side.  $\beta$ . Similar objects, but larger. They are in outline.  $\gamma$ . Seen with great distinctness (par. 45).
- Fig. 55. Scheme, illustrating the structure, apparently, of the objects figs. 40  $\alpha$ , 41  $\alpha$ ,  $\beta$ , 52, 54, 56, 83, 84, and of every object termed in this memoir a filament, flat filament, or band, *i. e.* a "fibre" (pars. 13, 14).
- Fig. 56. Turtle. Portion of muscle from the heart. It is a filament, composed of two interlaced spirals (par. 45); but very much larger than usual. At  $\alpha$  the filament is broadest: at  $\beta$  it is narrower, perhaps from elongation: at  $\gamma$  it is twisted; and it is the (narrow) edge of the filament that is here seen (par. 44 Note).
- Fig. 57. Chick *in ovo*; incubated fifteen days. Interlacing spirals.  $\alpha$ . Two nuclei, with orifices ("nucleoli"), in the space circumscribed by one of the spirals (par. 44).
- Fig. 58. Tadpole,  $5\frac{1}{2}''$ . Four spirals visible on one side of the fasciculus; in each of which were seen two filaments (par. 42). An appearance of fibres crossing one another (spirals entering into the formation of the investing membrane?) was observed at the outer part. They are not shown in the figure.
- Fig. 59. Tadpole. From the tail. A small muscle-fasciculus, in which are seen spirals surrounding objects, probably filaments, too minute to be examined in this state. On the left side, one of the spirals is ruptured. (par. 42).
- Fig. 60. Scheme, showing the structure of objects illustrated by fig. 55, in an altered state (see pars. 27, 38, 39).
- Fig. 61. Muscle-filament ("fibrilla") from the iris of a fish, on its flat surface (par. 45).
- Fig. 62. Tadpole, about  $6''$ . Sketch of the widened or brush-like extremities of two ruptured fasciculi of muscle (par. 119 Note.)  $\alpha$ . Two filaments ("fibrillæ"). The inner of these filaments presents its edge only. The outer filament exhibits at the upper part, its flat surface; and at the lower part, its edge: *i. e.* this filament is twisted (par. 45.). Dots represent the situations of the other filaments in these two fasciculi.
- Fig. 63. Tadpole. Sketch of a fasciculus of muscle, broken off at the upper part. The transverse and longitudinal striæ, are represented by lines, except at  $\alpha$ , where the structure is delineated fully. This part shows the edge of six filaments ("fibrillæ") (par. 45).  $\beta$ ,  $\beta$ ,  $\beta$ . These longitudinal striæ darker than the rest (par. 42).

- Fig. 64. Muscle;  $\alpha$ ,  $\gamma$ , from the Lobster (after boiling);  $\delta$ , from the Sheep.  $\alpha$ ,  $\gamma$ . Interlaced spirals, which are compound filaments. Their structure is seen at  $\beta$ . Dots represent the situation of longitudinal filaments, surrounded by the spirals  $\alpha$ ,  $\gamma$ .  $\delta$ . Appearance inducing the belief that the transverse striæ cross the fasciculus in a continuous line, until the parts are more minutely examined (see the objects  $\alpha$ ,  $\gamma$ , and par. 120).
- Fig. 65. Tadpole, 8<sup>'''</sup>. From the tail. Muscle-fasciculus more advanced than that in fig. 94. It presents on one side four interlacing spirals; each spiral a compound object. Their contents not shown.
- Fig. 66. Young Crab. Two portions of a fasciculus of muscle:  $\alpha$ . Contracted; and  $\beta$ , relaxed (see par. 52). The arrow shows the longitudinal direction of the fasciculus.
- Fig. 67. Tadpole. Two portions of a fasciculus of muscle.  $\alpha$ . The edges of four filaments ("fibrillæ") are seen, unchanged.  $\beta$ . Extremity, elongated to a point before being broken. In  $\beta$ , the direction of the spirals is very much altered. The upper part of  $\beta$  may serve to convey an idea of the state of a fasciculus in extreme relaxation (par. 51).  $\beta$  Appeared to be invested by a highly elastic membrane (par. 54). The extreme point of  $\beta$  was at the distance of  $\frac{1}{11}$ <sup>'''</sup> from  $\alpha$ .

## PLATE VIII.

- Fig. 68. Tadpole,  $5\frac{1}{2}$ <sup>'''</sup>. From the tail. Appearance near the surface of an object such as the larger of those in fig. 73, after the addition of acetic acid of the strength of distilled vinegar. The discs it presented (fig. 68) seem to have been the essential part of spirals such as the larger of those in fig. 73; the outer part of which had been removed by the acetic acid.  $\alpha$ . The discs seemed to be composed of minuter discs (par. 55).
- Fig. 69. Tadpole, about 5<sup>'''</sup>. From the tail. Spirals detached from a fasciculus of muscle; in a quadruple coil (par. 80).
- Fig. 70. Tadpole, about 5<sup>'''</sup>. From the tail. Spirals detached from a fasciculus of muscle; in a double coil (par. 80).
- Fig. 71. Strawberry (*Fragaria vesca*, LINN.). Spiral from the leaf-stalk. This spiral is a compound object, containing filaments ("fibres") (par. 80).
- Fig. 72. Sheep. From the white substance of the cerebellum. A spiral filament.  $\alpha$ . Structure of this filament (par. 35).
- Fig. 73. Tadpole,  $5\frac{1}{2}$ <sup>'''</sup>. From the tail. Sketch of two sets of spirals; several being parallel in each. The spaces circumscribed by these spirals presented discs; and the spirals exhibited more or less distinct traces of discs in their substance (par. 55).

- Fig. 74. Flax, dividing and subdividing into filaments ("fibres"). At  $\alpha$ , and in part of  $\beta$ , a membrane-like investment prevented the structure from being seen (pars. 69, 62).
- Fig. 75. Similar division of flax. The same fasciculus presented the three states  $\alpha$ ,  $\beta$ ,  $\gamma$  (par. 69).
- Fig. 76. Similar division of flax; the states  $\alpha$ ,  $\beta$ ,  $\gamma$  and  $\delta$ , having been seen in the same fasciculus (par. 69).
- Fig. 77. Sheep. From the spinal chord †. Sketch of a fasciculus of nerve. At  $\alpha$ , a spiral crosses the entire fasciculus: at  $\beta$ , one half of the fasciculus is crossed by another spiral (par. 39).
- Fig. 78. Sketch of mould from a ripe berry (*Rubus fruticosus*, LINN.). It presents a fasciculus of filaments, surrounded by a spiral filament (par. 67).
- Fig. 79. Tadpole, about 5<sup>'''</sup>. Portion of muscle. From the tail, presenting interlaced spirals (par. 45). These are more transversely curved at the upper part, and the object (filament) is therefore wider here than below, where the direction of the curves is more oblique. At a part still lower than the figure shows, the object was as broad as at the upper part of the figure: and here also there was a corresponding change in the direction of the spirals (par. 51).
- Fig. 80. Sheep. From the spinal chord †. Sketch of spiral filaments ( $\alpha$ ), surrounding filaments having a more (yet not perfectly) longitudinal direction ( $\beta$ ). Internal to the latter, was a broad "band-like axis" ( $\gamma$ ), exceedingly delicate, and consisting of very minute filaments, such as those in fig. 81. (par. 36).
- Fig. 81. Sheep. From the spinal chord †.  $\alpha$ . Dots, showing the curves of a spiral. These curves presented great irregularity in their direction, which has not been imitated in the figure.  $\beta$ . Delicate "band-like axis" (corresponding to that in fig. 80), consisting of minuter filaments. Spirals seen in the latter (par. 36).
- Fig. 82. Sheep (?). From the grey substance of the cerebellum. Sketch of a fasciculus of nerve, consisting of two halves. Two spiral filaments are seen, the one surrounding half of the fasciculus, and the other surrounding the whole of it. The latter spiral is removed from the fasciculus at the lower part (par. 39).
- Fig. 83. Sow Thistle (*Sonchus oleraceus*, LINN.). From the root. Sketch of two interlaced spirals, invested by something like a membrane (par. 83).
- Fig. 84. Tadpole. Sketch of two interlaced spirals in muscle, forming a very large filament (par. 45). Between  $\alpha$  and  $\beta$ , the filament is twisted; presenting here, therefore, a thinner part, its edge.
- Fig. 85. Sheep. From the spinal chord †. Sketch of a fasciculus of nerve. The upper

† See the note, p. 120.

or outer part  $\alpha$ , is in mere outline. The lower or inner part appeared to correspond to that marked  $\gamma$  in fig. 80, and  $\beta$  in fig. 81; but was in a more advanced state, the filaments (very minute and delicate in figs. 80 and 81) having enlarged, and separated from one another. The spirals in these filaments are represented at certain parts ( $\beta$ ) (par. 36).

Fig. 86. Sheep. From the spinal chord †. Sketch of filaments. They represent a state more advanced than those in fig. 85 ( $\beta$ ) (par. 36).

Fig. 87 to 90. From the root of the Sow Thistle. Most of the objects represented in these figures, have the appearance of being merely "dotted," when viewed at certain distances (par. 83).

Fig. 87. The tubes sketched in this figure were filled with interlaced spirals, which are represented only at certain parts. In the tube  $\alpha$ , the direction of these spirals is unaltered. In  $\beta$ , partly separated from the other tubes, the spirals have been distorted; precisely the change that takes place in muscle (par. 54).  $\gamma$ . Extremity of the tube  $\beta$ , elongated to a point, with a corresponding elongation of the contained spirals. Compare with fig. 67, from muscle, and see the description of fig. 67.

Fig. 88. Corresponding tube, in a state more advanced, and the spirals, therefore, more numerous and smaller.  $\alpha$ . Surface of the tube ("dots").  $\beta$ . Interior (par. 83).

Fig. 89.  $\alpha$ . Interlaced spirals, nearly resembling those in fig. 87.  $\beta$ . Interlaced spirals in a distorted state (par. 54).  $\gamma$ . Drawn by reflected light, exhibits interlaced spirals. Compare with figs. 92, 93, and 94, from muscle.

Fig. 90. The tube in this figure presents the appearance, merely, of transversely elliptical, and bright "pores" or "dots;" which in reality are spaces between the curves of interlacing spirals, such as those in figs. 87, 88, and 89, the curves being concealed in fig. 90. The more superficial of the spirals in fig. 90, seem to be coalescing into a membranous substance, which conceals the inner ones.  $\alpha$ . One of the "septa," formed by the interlacing spirals (par. 83).

Fig. 91. Sheep. Filament consisting of interlaced spirals, from the cornea. The cornea appeared to be wholly composed of filaments in the densest aggregation, and running in every direction.

Fig. 92. Turtle. Interlaced spirals, from the heart.

Fig. 93. Chick *in ovo*; incubated fifteen days.  $\alpha$ . Sketch of interlaced spirals in muscle. On the right, at the lower part, are portions of a ruptured spiral, adherent to the rest. The object  $\beta$  represents a young fasciculus of muscle. Compare it with fig. 89  $\gamma$ , and see par. 83.

† See the note, p. 120.

- Fig. 94. Tadpole, about 5<sup>'''</sup>. From the tail. Young muscle-fasciculus, presenting on one side three interlacing spirals, with their contents. This object very much resembles  $\beta$  of fig. 93, but is larger. The alternation of the inner spirals in a large fasciculus, may be seen by gradually shortening the focal distance.
- Fig. 95. Tadpole, 5 $\frac{1}{2}$ <sup>'''</sup>. Superficial part of a muscle-fasciculus presenting interlaced spirals (par. 42).
- Fig. 96. Tadpole, about 6<sup>'''</sup>. Muscle-fasciculus presenting on one side five interlaced spirals (par. 42). The transverse striæ somewhat distorted by manipulation.

## PLATE IX.

- Fig. 97. From mould formed on a portion of the heart.  $\alpha$ . Tube containing filaments, apparently spirals, running in different directions, and crossing one another. The filaments are dotted merely. It is their edges which are thus represented.  $\beta$ . Tube containing interwoven spiral filaments, in outline except at one part (par. 67).
- Fig. 98. From the same mould. The figure represents two parts of a tube, containing filaments. In the part  $\alpha$ , some of the filaments are very longitudinal; others more spiral, and interlacing. In the part  $\beta$ , the spiral filaments ( $\delta$ ) are more *transversely* spiral: they seemed to have been broken off at this part, and had perhaps recoiled in consequence (par. 39). At  $\gamma$ , are filaments transversely spiral; and forming a narrow mass, occupying only the middle of the tube.  $\delta$ . Structure of the filaments.
- Fig. 99. Sheep. From the spinal chord †. Fasciculus of nerve. The figure represents only a part of the many spiral filaments seen in this object. Between some of these spiral filaments ( $\alpha$ ) were enlargements ( $\beta$ ).  $\gamma$ . Structure of the spiral filaments, as well of those at  $\alpha$ , as of the others.  $\delta, \delta$ . Longitudinal filaments.  $\epsilon$ . Central space, much more pellucid than the rest. This central part is the place of origin of new substance. There seemed to be in the interior, filaments interlacing with one another. These are not represented (par. 39).
- Fig. 100. Sketch of fasciculi of flax. In  $\alpha$ , are seen longitudinal and spiral filaments. In  $\beta$ , the filaments seemed to interlace (par. 68).
- Fig. 101. Sketch of a fasciculus of flax; the interior not shown. Here and there, and in some degree at pretty regular distances, it was crossed by transverse filaments running in opposite directions. At  $\alpha$ , there were two of these filaments in each direction (par. 68); at  $\beta$ , there was only one. Where these filaments ( $\alpha$  and  $\beta$ ) were situated, the diameter of the fasci-

† See the note, p. 120.



culus was greater than elsewhere, independently of the presence of the filaments ( $\alpha$  and  $\beta$ ). In some parts a single transverse filament crossed the fasciculus, without being met by one in the opposite direction.

- Fig. 102. Sketches of fasciculi (the "primitive fibres" of authors) in the ischiatic nerve. All that is intended by this figure, is to show the breadths of the fasciculi, and to give some idea of the direction of such of the contained filaments ("white substance," par. 28) as are represented, which is by no means all that were present in these objects.  $\alpha$  and  $\gamma$ . Filaments interlacing.  $\beta$ . Filaments more longitudinal. In  $\beta$ , the interior seemed fluid, or nearly so.
- Fig. 103. Chick *in ovo*; incubated twelve days. Very young muscle-tube in a state resembling that in fig. 111 (see the description of fig. 111). The longitudinal filaments are all represented by dots except one, which is seen on its flat surface. The spiral filament is in outline.
- Fig. 104. Sketch of a fasciculus of filaments from mould on a ripe berry. The same mould as that in fig. 78.
- Fig. 105. Sheep. Sketch, showing the diameter, and undulating, soft appearance of two of the fasciculi in the medullary substance of the cerebrum. In one of these, some of the contained filaments are represented.
- Fig. 106. Sheep. Sketch of fasciculi from the cortical substance of the cerebrum, wholly composed of filaments. One of these fasciculi,  $\alpha$ , is in outline only. In the other,  $\beta$ , filaments are represented; but these are merely dotted in, with one exception,  $\gamma$ . These filaments did not appear tense, but of the same softness as those from the olfactory nerve, fig. 108.
- $\delta$ . Division of the fasciculus into two parts.
- Fig. 107. Rabbit. Fasciculus from the optic nerve. It consists of filaments, lying loosely together, and less distinctly circumscribed by a membranous investment than those of the "white substance" in, for instance, the ischiatic nerve (par. 32).
- Fig. 108. Rabbit. Fasciculus from the olfactory nerve. See the description of fig. 107, which is quite as applicable here. The appearance is well represented in this figure (par. 32).
- Fig. 109. Sketch of a fasciculus of flax. It represents very few of the filaments seen in the interior.  $\alpha$ . Membrane at the surface divided at this part.  $\beta$ . Filament having a longitudinal direction.  $\gamma$ . Direction of more oblique filaments.  $\epsilon$ . Central body, surrounded apparently by a fluid. In other parts of the fasciculus,  $\epsilon$  was not visible. *It appeared to have resolved itself into the interlaced filaments fig. 110; each of the threads in  $\epsilon$  producing several filaments.*
- Fig. 110. Part of the same fasciculus of flax as that in fig. 109.  $\alpha$ . Division of an investing membrane. In the interior were interlaced, and apparently

spiral, filaments, probably arisen out of part of  $\varepsilon$  fig. 109. See the explanation of fig. 109. Several of these filaments are represented in the figure, and parts of others are shown in outline. These filaments were tense. The direction of  $\beta$  seemed longitudinal.

- Fig. 111. Chick *in ovo*; incubated twelve (?) days. From the leg. A very young muscle-tube in which there are seen five filaments. The figure represents the edges of these filaments. Two of them are close together, and so applied as to produce almost transverse striæ; three are loosely situated in the tube. Such filaments appear to become enlarged into such as those in figs. 40, 41.
- Fig. 112. Frog. From a nerve of the leg.  $\alpha, \beta$ . Fasciculi or tubes (the so-called "primitive fibres"). In  $\alpha$ , is seen one of the filaments ("white substance," par. 28) which lie loosely together in these tubes. This filament is on its flat surface. Dots indicate the situation of other filaments. In  $\beta$  are represented four of these filaments, all on their edges. The direction of three is oblique.  $\gamma$ . Filament, the structure of which was remarkably distinct.  $\delta$ . Similar filament, but more minute and on its edge.  $\gamma$  and  $\delta$  seen in fasciculi such as those at  $\alpha$  and  $\beta$ .
- Fig. 113. Sketch of a fasciculus of flax.  $\alpha$ . Spiral, composed of two filaments, the structure of which is seen at the extremity. Compare with  $\alpha \alpha$  of the present figure; with spiral from the leaf-stalk of the Strawberry, fig. 71; with that in flax fig. 101; with those in muscle, figs. 69, 70; and see par. 80 on the reproduction of spirals by division.  $\alpha \alpha$ . Spiral running in the opposite direction; and consisting of *four* filaments (see the reference above). The filaments surrounded by the spirals  $\alpha$  and  $\alpha \alpha$ , are seen for the most part on their edges, in the figure. They have the same structure as the filaments of the spirals  $\alpha$  and  $\alpha \alpha$ . A cavity in the middle of the fasciculus. Acetic acid.
- Fig. 114. Rabbit. Filaments found in the retina. The number seen was very great.  $\alpha$ . Is on its edge.  $\beta$ . The upper part on its edge; the lower on its flat surface (pars. 6, 14).
- Fig. 115. Rabbit. Filaments from the medullary substance of the cerebrum.  $\alpha$ . On its edge;  $\beta$ . on its flat surface (pars. 6, 14).
- Fig. 116. Rabbit. From the cortical substance of the cerebrum.  $\beta, \gamma$ . Filaments, the former on its flat surface, the latter on its edge (pars. 6, 14).
- Fig. 117. Frog. From the spinal chord.  $\alpha, \alpha, \beta$ . Filaments;  $\alpha, \alpha$ , on their edges;  $\beta$ . on its flat surface (pars. 6, 14).  $\gamma$ . Varicose object, the enlargements often at pretty equal distances. I have seen the pellucid central part (nucleus?) of one of these enlargements to run along the object, and pass into another enlargement, which was thus increased in size.
- Fig. 118. Rabbit. Sketch of an object noticed in the lachrymal gland (see par. 40).

$\alpha$ . Interlacement of filaments.  $\beta$ . Structure of these filaments.  $\gamma$ . Spirals.  
 $\delta$ . Their structure.  $\varepsilon$ . Outline of trunk; into which  $\zeta$  passed.

Fig. 119. Advanced state of such an object as  $\varepsilon$ , fig. 109.

### PLATE X.

Fig. 120. Tadpole, about  $5\frac{1}{2}'''$ . Corpuscles, having the same appearance as young blood-corpuscles, connected like the links of a chain (par. 23).

Fig. 121. Tadpole, about  $6'''$ . Sketch of muscle-tubes, as seen lying together, several of them exactly parallel, and the whole apparently discharged from a parent structure (par. 42). No more than the most superficial portion of their contents is shown; and this only at certain parts. Some of these tubes ( $\alpha$ ) present at least two spirals; in another ( $\beta$ ) are interlaced spirals; and in a third ( $\gamma$ ), there are rings for the formation of interlacing spirals (par. 42). Very weak acetic acid.

Fig. 122. Tadpole,  $5\frac{1}{2}'''$ . Similar tubes.  $\alpha$ . The direction of the spirals is exceedingly oblique.  $\beta$ . Interlaced spirals.  $\delta$ . The number of spirals appears to be three.

Fig. 123. Tadpole,  $5\frac{1}{2}'''$ . From the tail. Muscle-fasciculus in which the objects  $\gamma$  are surrounded by spirals,  $\beta$ , in such a manner, that each  $\gamma$  is shared by two of  $\beta$ .  $\alpha$ . Larger spiral, common to the foregoing (par. 54).

Fig. 124. Tadpole. Muscle-tube representing different states of the more central ( $\alpha$ ,  $\beta$ ), as well as the conditions of the more superficial ( $\gamma$ ,  $\delta$ ) parts.  $\alpha$ . Discs not in lines.  $\beta$ . Larger discs, near the centre, and in something like lines.  $\gamma$ . Discs overlapping one another, and in some parts appearing as if linked together. These more superficial than the discs  $\beta$ , and nearly on a level with the interlaced spirals  $\delta$ ; which correspond to  $\gamma$  of fig. 48.

Fig. 125. Turtle. From the heart. Sketch of interlacing spirals. Each spiral is a flat and compound filament; the edge of which filament is directed towards the observer. Every spiral *thread* appears to contain nuclei; and may therefore become a compound filament (par. 55).

Fig. 126. Dandelion (*Leontodon Taraxacum*, LINN.). Sketch of a portion of the pappus. Longitudinal filaments ( $\beta$ ) in the interior are represented by dots. These filaments are collected into fasciculi by spiral filaments ( $\alpha$ ); the longitudinal filaments being represented by rows of dots, their structure is shown at  $\gamma$ .

Fig. 127. Groundsel (*Senecio vulgaris*, LINN.). From the root.  $\alpha$ ,  $\beta$ . Sketch of filaments. The structure seen in certain of them.  $\gamma$  Represents the structure of the filaments  $\beta$ , and their larger size.

Fig. 128. Nettle (*Urtica dioica*, LINN.). The figure represents, between  $\alpha$  and  $\beta$ , the breadth of a hair from the leaf-stalk; and filaments on the inner sur-

face of the hair.  $\gamma$ . Structure of the filaments, and frequent position with reference to the surface. The dots show merely the direction of other of the filaments: this direction being spiral. Their distance from one another is different in different hairs. A similar appearance observed in hairs from the under surface of the leaf and from the stem (par. 72).

Fig. 129. Foetal Sheep. From the crystalline lens. Sketch of tubes containing discs. A space in the middle of the tubes (see par. 61).

Fig. 130. Chick *in ovo*; incubated fifteen days. From the crystalline lens. Chiefly in outline.  $\alpha$ . Composed of filaments, two of which are represented in the figure.  $\beta$ . An object composed of filaments, more of which were present on the right hand than on the left; whence the greater thickness at the former part. The arrow indicates the longitudinal direction of these filaments. At one end of this object ( $\beta$ ) are pendent portions, not of entire filaments, but of spiral threads composing filaments; these spiral threads hanging from the extremities of certain filaments where broken off.  $\gamma$ . Portion of a fasciculus of filaments containing a nucleus, which displaces the contiguous filaments. Many such fasciculi are seen in fig. 132. In the nucleus are three discs, with an orifice in each.

Fig. 131. Bream. From the central part of the crystalline lens.  $\alpha$ . Two spirals running in opposite directions, the one within the other.  $\beta$ . Two interlaced spirals containing filaments.  $\gamma$ . Two interlaced spirals.  $\delta$ . Filament enlarging. Certain states of filaments pass into the toothed fibre, discovered by Sir DAVID BREWSTER (see par. 62).

Fig. 132. Chick *in ovo*; incubated fifteen days. From a more central part of the same lens, as that from which fig. 130 was taken. Sketch of a flat object, folded at  $\beta$ . It was composed of fasciculi,  $\gamma$ , resembling  $\gamma$  of fig. 130. These fasciculi consisted of filaments, among which were nuclei, displacing, as at  $\alpha$ , the contiguous filaments.

Figs. 133 to 136. Rabbit. From the cartilage of the ear.

Fig. 133. This figure represents in outline the situations of several cells. The nuclei of these cells are not shown in all of them. In one instance,  $\alpha$ , the nucleus resembles a ball of twine (see par. 18).  $\beta$ . Some of the filaments of the intercellular substance. The nucleus frequently elliptical in form.

Fig. 134. Cell, for the most part in outline. The walls composed of interlaced filaments.  $\alpha$ . Structure of the filaments. The central portion of the nucleus had divided into two parts (centres), held together in a remarkable manner by interlaced filaments, proceeding from these parts. Possibly this division of the nucleus denotes incipient division of the cell into two minuter cells. Each of the two parts (centres) of the nucleus had its orifice ("nucleolus"); the two orifices

nearly facing one another. Around the orifice were pale discs not yet arranged into a filament (see par. 18).

Fig. 135. Nuclei of two other cells. One centre is seen in the nucleus  $\alpha$ , surrounded by filaments. This centre has its orifice. The nucleus  $\beta$  presents several parts, appearing as though held together by interlacing filaments. Yet perhaps this division of the nucleus into several parts denotes incipient division of the cell into as many minuter cells, of which each part of the divided nucleus would have been the nucleus. See pars. 18, 19.

Fig. 136. Outline of two cells, the nuclei of which had escaped. A filament extended from the situation of an unwinding nucleus to the wall of one of the cells.

Fig. 137. Chick *in ovo*; incubated fifteen days. Outline of cells in the cartilage of one of the phalanges (the terminal one). Filaments indistinctly seen at  $\alpha$ . In the nuclei filaments were not seen (as in figs. 133 to 136); yet the discs of which the nuclei were composed ( $\beta$ ), appeared like rings: and the central portion of the nucleus  $\gamma$  consisted of two halves as in fig. 134.

Fig. 138. Chick *in ovo*; incubated fifteen days. Filament observed in cartilage of a bone of the leg, more advanced than that in fig. 137.

Fig. 139. Outline of the hair of a Caterpillar, containing filaments, one of which is seen at  $\alpha$  (par. 71).

Fig. 140. Sketch of part of two feather-like bodies from the wing of a Gnat.  $\alpha, \alpha$ . Structure of the filaments in these objects.

Fig. 141. Sketch of feather-like bodies from the wing of a Butterfly.  $\alpha$ . The object entire, and young:  $\beta$ . part of an object of the same kind, more advanced.  $\gamma$ . Structure of the filaments in the object  $\alpha$ .  $\delta$ . Structure of spirals producing transverse (as well as longitudinal) striæ in the object  $\beta$ .

Fig. 142. Spider's web. Fasciculus of filaments. The filament  $\alpha$  presents its edge at the middle part. Of the other three filaments, two are on their edge, and the third is on its flat surface. Citric acid. (par. 75).

Fig. 143. Spider's web. Filament on its edge. It crossed some feather-like objects from the wing of a Butterfly; part of one of which is represented in outline in the figure. Citric acid. (par. 75).

## PLATE XI.

Figs. 144 to 147½ are not drawn on the same scale as the rest. For the first three of these, the author is indebted to a friend. Fig. 147 is taken from a drawing by Dr. HESSE, in FRORIEP's Notizen, Juli 1840, No. 309, p. 2. It represents part of Dr. HESSE's fig. 5.

- Fig. 144. Frog. Sketch of a large muscular fibril from the heart ;  $\alpha$ , on its edge (interspaces oblique) ;  $\beta$ , on its flat surface (par. 92).
- Figs. 145, 146. Newt (*Triton cristatus*, LINN.). Sketch of red blood-discs containing filaments ;  $\alpha$ , on the edge (interspaces oblique) ;  $\beta$ , on the flat surface (par. 92).
- Fig. 147. "Transverse section of the tooth of the Ornithorhynchus near the apex, where the tubes have become closer" (par. 99).
- Fig. 147½. From HENLE. (Allgemeine Anatomie. Lehre von den Mischungs- und-Formbestandtheilen des menschlichen Körpers, 1841. Taf. IV. fig. 5. I.). From the *nervus ischiadicus* of the Frog ; " $\alpha$  ausgetretenes Mark,  $\beta$  zusammengefallene Scheide."
- Fig. 148. Man. Sketch of objects from the blood-clot.  $\alpha$ . Parent cell ; filled with blood-corpuscles having the form of Ammonites.  $\beta$ . More advanced states of such blood-corpuscles, discharged from a parent cell, and seen with others lying in a group. They have the spiral form.  $\gamma$ . Similar blood-corpuscles of a larger size, *i. e.* in a state more advanced : the upper one beginning to undergo division.  $\delta$ . Spiral fasciculus of filaments (par. 97).
- Fig. 149. Newt (*Triton cristatus*, LINN.). Sketch of blood-corpuscles from the forming clot. No addition had been made (par. 96). All are flask-like vesicles (par. 96).  $\alpha$ . The membrane without folds.  $\beta$ . Folds are seen.  $\gamma$ . The filament protruding.  $\delta$ . Two filaments visible in the interior : the nucleus apparently giving them off.
- Figs. 150 to 152. Sketches of blood-corpuscles, and of filaments derived from them : as seen in the clot of the Frog and Newt.
- Fig. 150. Parent corpuscle, or cell, containing a coiled filament ( $\alpha$ ), which surrounds two young coiled filaments ( $\beta, \beta$ ). A pellucid nucleus in each of the latter (par. 99).
- Fig. 151. Parent corpuscle, or cell, containing a coiled filament, which surrounds many young coiled filaments.
- Fig. 152. Coiled filaments, derived from blood-corpuscles :  $\alpha$ , with a cavity in the centre ;  $\beta$ , unwound.
- Fig. 153. Sheep. From the clot of blood : nine hours after the bleeding. Sketch of filaments.  $\alpha$ . A spiral having been produced, it is elongating.  $\beta$ . The elongation has proceeded farther ; and at  $\gamma$  has produced the appearance of a merely twisted filament. Of these filaments, about half a dozen lay abreast, and some of them were united at their extremities.  $\delta$ . Structure of the filaments.  $\epsilon$ . Similarly twisted filaments.  $\zeta$ . Spiral ; apparently an altered red blood-disc. The whole blood-red.
- Fig. 154. Newt (*Lisso-triton punctatus*, BELL). From the blood-clot. Sketch of an

Fibre.



1  
Man.



2  
Man.

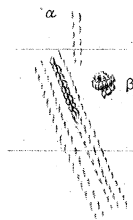

3  
Man.

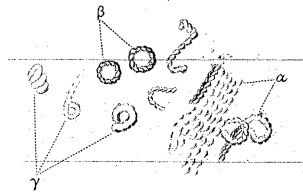

4  
Man.



5  
Sparrow.

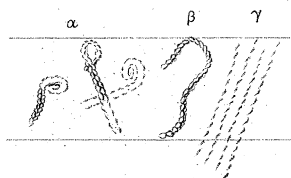

6  
Sparrow.

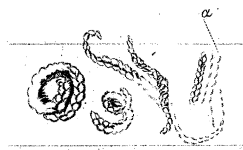

7  
Chick.

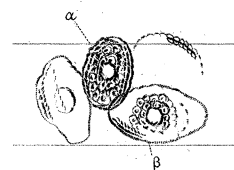

8  
Turtle.

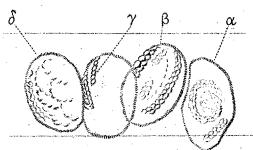

9  
Frog.

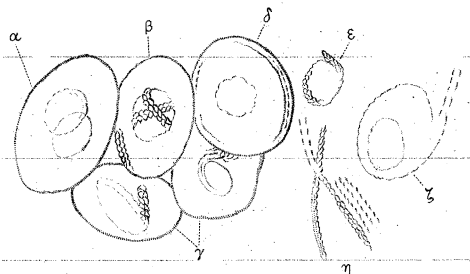

10  
Newt.

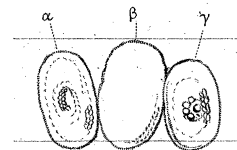

11  
Toad.



12  
Skate.

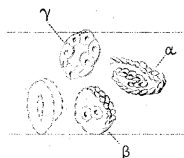

13  
Cod.

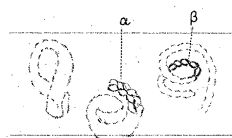

14  
Lobster.



15  
Oyster.

All the objects are seen of their relative sizes, being alike magnified 600 Diameters. Their actual sizes may be determined by reference to the spaces they occupy between the horizontal lines, which are 100<sup>th</sup> of a Paris line apart in the micrometer itself. Thus the actual length of a in fig. 5. is 200<sup>m</sup> (Paris line.)

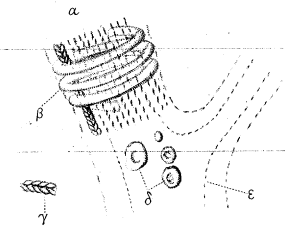

16  
Blood vessels.

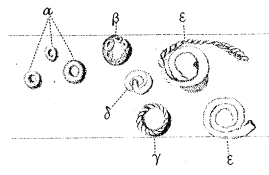

17  
Nerve.

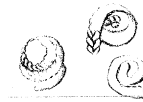

18  
Nerve.

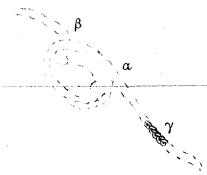

19  
Nerve.



20  
Nerve.

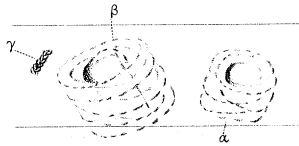

21  
Nerve.

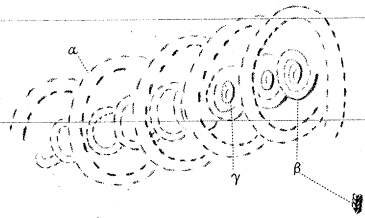

22  
Nerve.

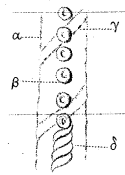

23  
Muscle.

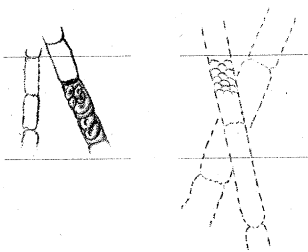

24  
Nerve.

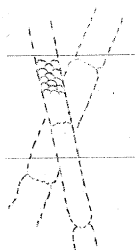

25  
Mould.

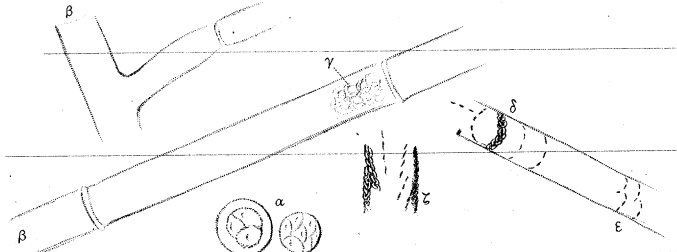

26  
Mould from Cheese.

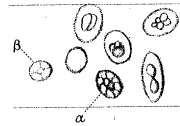

27  
Mushroom.

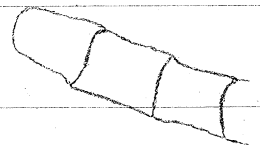

28  
Muscle.



29  
Muscle.

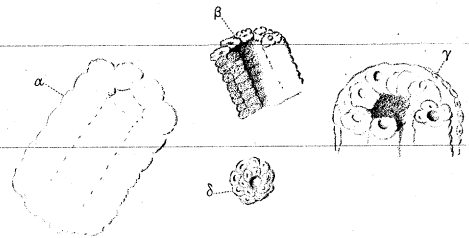

30  
Muscle.



31  
Muscle.

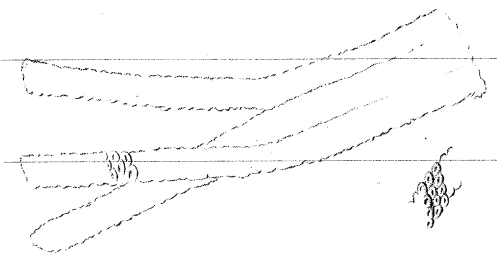

32  
Muscle.

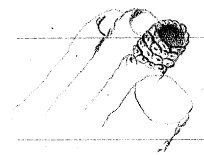

33  
Muscle.

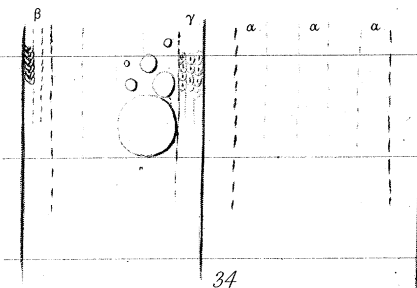

34  
Mould.

All the Objects are magnified 600 Diameters.

The horizontal lines are described at the foot of Plate V.



Fibre.

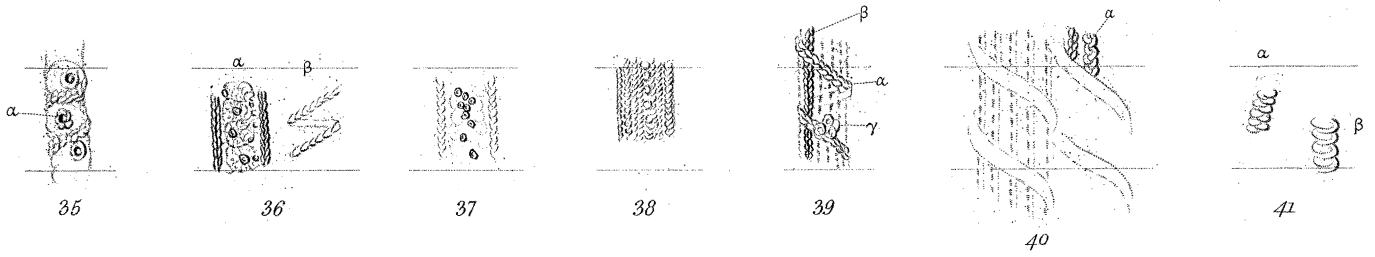

The above Figures, Chick 12 days.

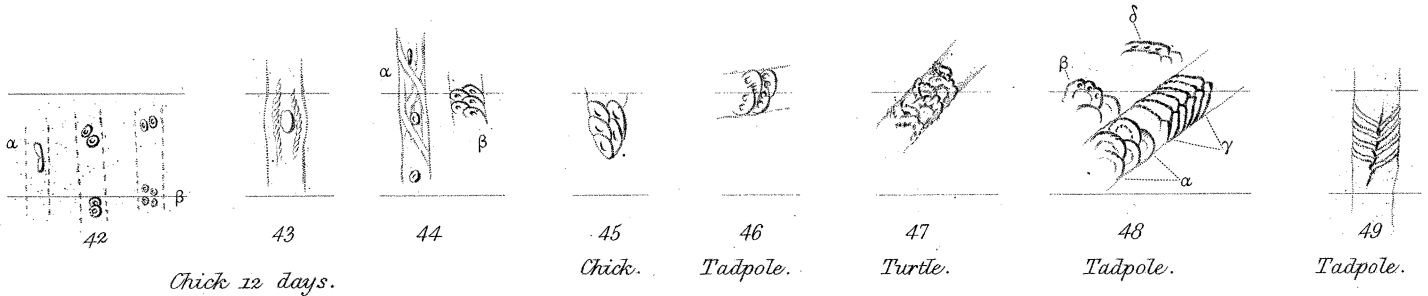

Chick 12 days.

Chick.

Tadpole.

Turtle.

Tadpole.

Tadpole.

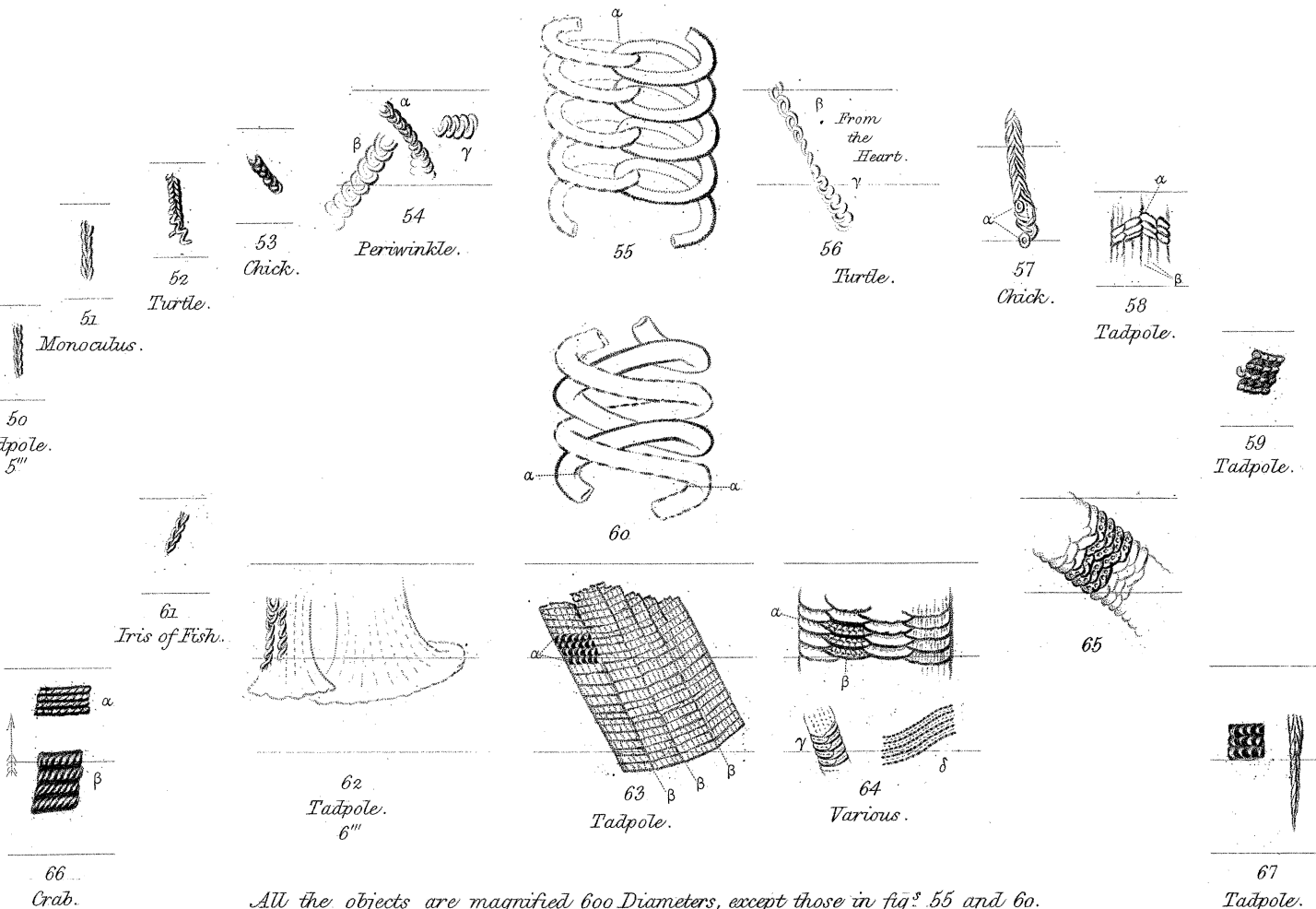

All the objects are magnified 600 Diameters, except those in figs 55 and 60.

The horizontal lines are described at the foot of Plate V.

This Plate represents the Formation &c. of Muscle.

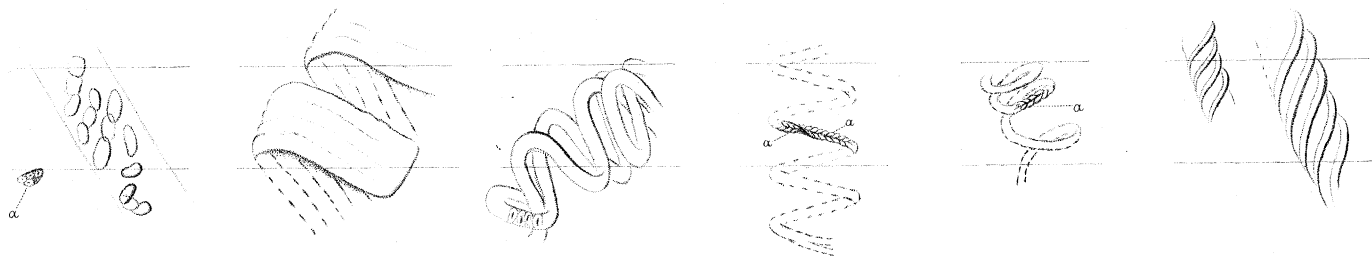

68 Muscle.

69 Muscle.

70 Muscle.

71 From the Leafstalk of the Strawberry. (a double coil)

72 Nerve.

73 Muscle.

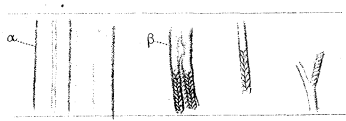

74 Flax.

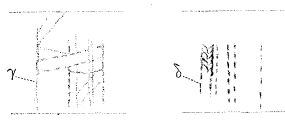

75 Flax.

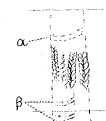

77 Nerve.



78 Mould.

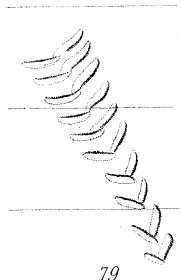

79 Muscle.

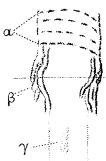

80 Nerve.

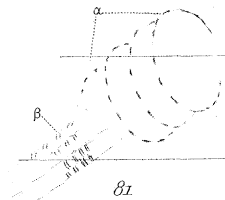

81 Nerve.

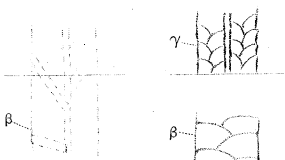

76 Flax.

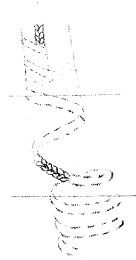

82 Nerve.

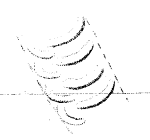

83 From the Sow Thistle.



84 Muscle.

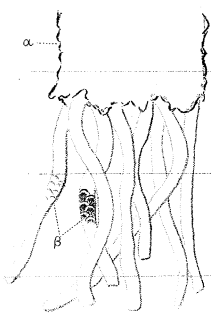

85 Nerve.



86 Nerve.



Fig<sup>s</sup> 87 to 90; from the Sow Thistle.

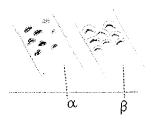

88

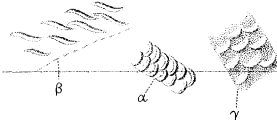

89

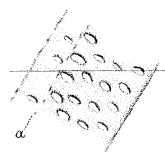

90



91 Cornea.



92 Muscle.



93 Muscle.



94 Muscle.

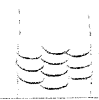

95 Muscle.



96 Muscle.

All the Objects are magnified 600 Diameters.

The horizontal lines are described at the foot of Plate V.

Fibre.

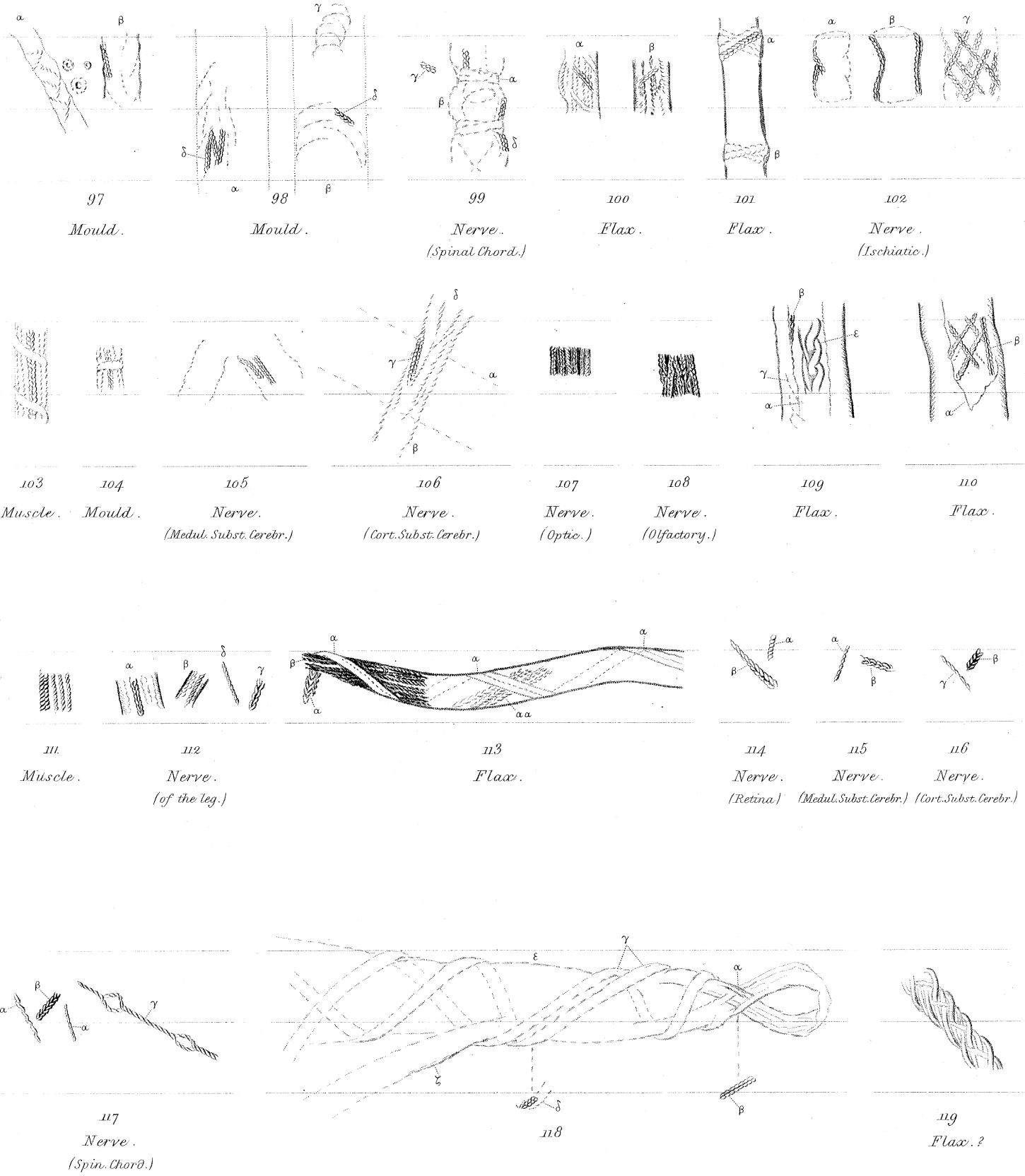

All the Objects are magnified 600 Diameters.

The horizontal lines are described at the foot of Plate V.

Fibre



120

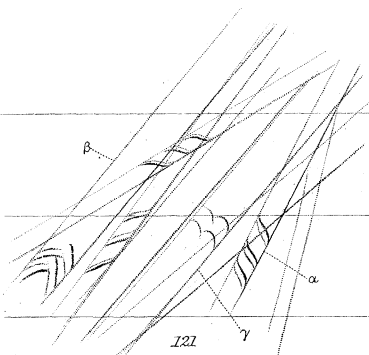

121

Very young Fasciculi of Muscle.

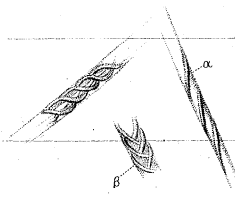

122

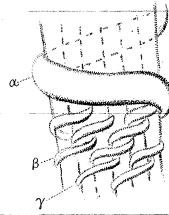

123

Fasciculi of Muscle.

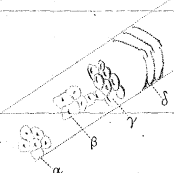

124

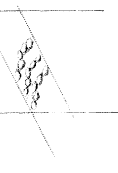

125

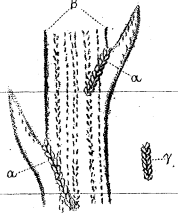

126

Pappus.

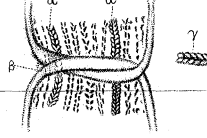

127

From the common Groundsel.

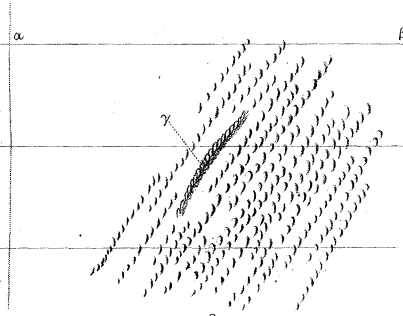

128

Hair of Nettle. ( $\alpha$   $\beta$  its Diameter.)

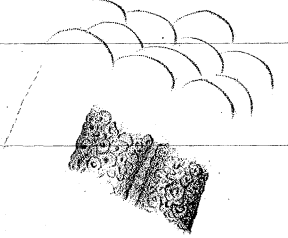

129

Cryst. Lens.

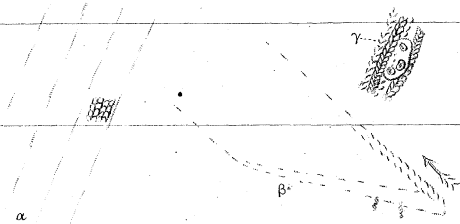

130

Cryst. Lens.

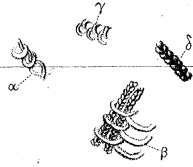

131

Cryst. Lens.

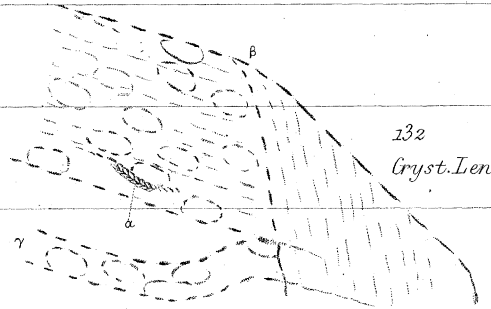

132

Cryst. Lens.

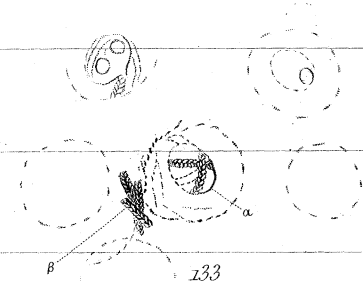

133

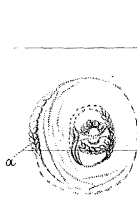

134

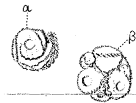

135

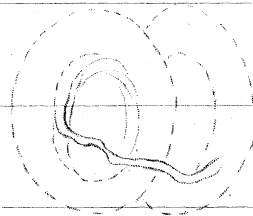

136

Cartilage of the Ear.

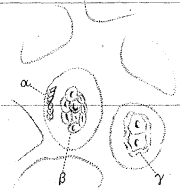

137

Cartilage of Bone.



138

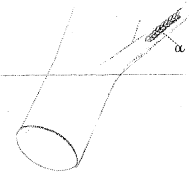

139

Hair of Caterpillar.

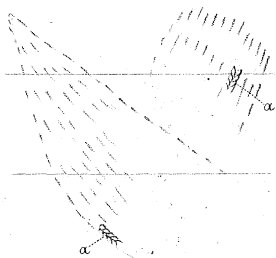

140

From a Gnat's Wing.

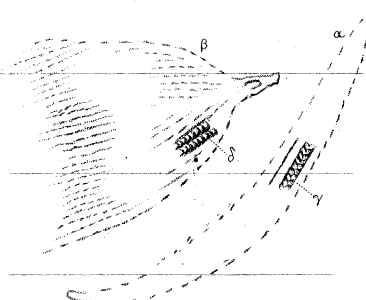

141

From a Butterfly's Wing.



142

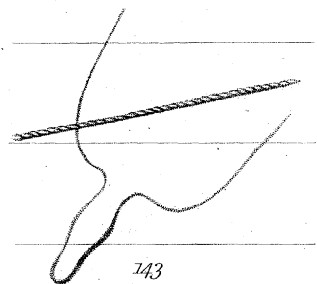

143

From the Spider's Web.

All the Objects are magnified 600 Diameters.

The horizontal lines are described at the foot of Plate V.

Fibre

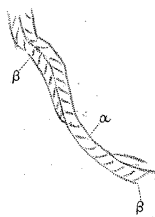

144

Enlarged Muscular Fibril.  
(Sketched by J.A. Bostock.)



145

Corpuscles of the Blood, containing Filaments.  
(Sketched by J.A. Bostock.)



146

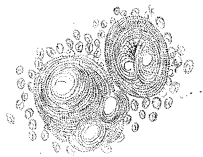

147

Section of a Tooth.  
(from Dr. Hesse.)

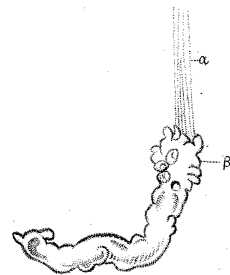

147 1/2

Nerve (from Dr. Henle.)



a



b



γ

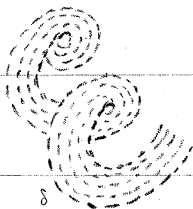

δ

148

Blood-corpuscles passing into Spiral Filaments.  
From the Clot of Human Blood.

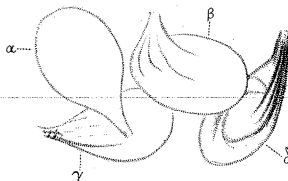

149

Blood-corpuscles containing Filaments  
From the Clot of the Newt's Blood.

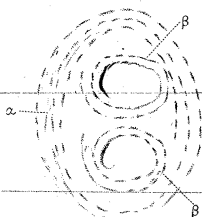

150



151

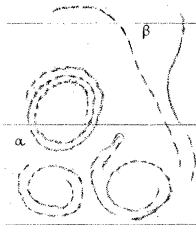

152

From the Blood-clot of the Frog and Newt.

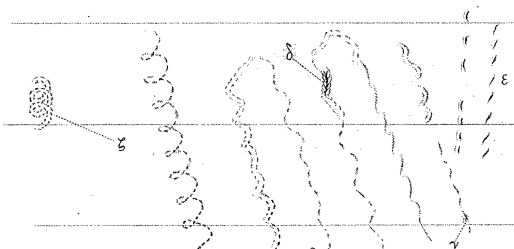

153

From the Blood-clot of the Sheep.

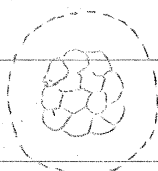

154

From the Blood-clot  
of the Newt.

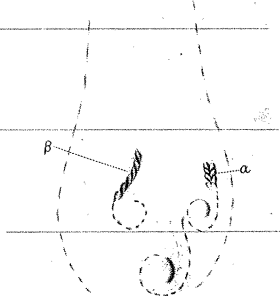

155

Hair of the Fetal Sheep.

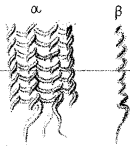

156

Voluntary Muscle  
of the Shrimp.

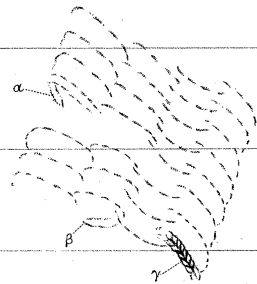

157

Voluntary Muscle  
of the Lobster.

All the Objects except those in the upper line are magnified 600 Diameters.

The horizontal lines are described at the foot of Plate V.

enlarged blood-corpuscle, the nucleus of which was undergoing division, for the purpose of producing young corpuscles.

- Fig. 155. Sketch of the hair-bulb in a foetal sheep; which contained nuclei, unwinding into filaments, the filaments interlacing.  $\alpha$ . Structure of the filament, as seen on its flat surface.  $\beta$ . Edge of the filament (par. 123).
- Fig. 156. Shrimp.  $\alpha$ . Sketch of a fasciculus of voluntary muscle, presenting interlaced spirals; some of which are seen pendent at the lower part.  $\beta$ . One of these spirals, the windings of which were distinctly followed.
- Fig. 157. Lobster. Sketch of a fasciculus of voluntary muscle: at the lower part *broken off short*; at the middle part *notched* (pars. 118—122).  $\alpha, \beta$ . Displaced extremities of the ruptured spirals.  $\gamma$ . Structure of the spirals.

Fig. 1.



Fig. 2.

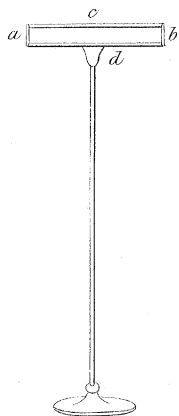

Fig. 3.

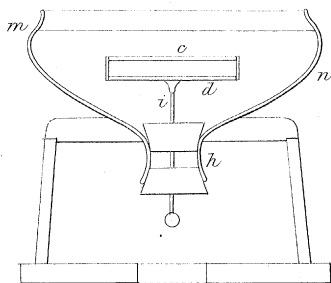

Fig. 7.

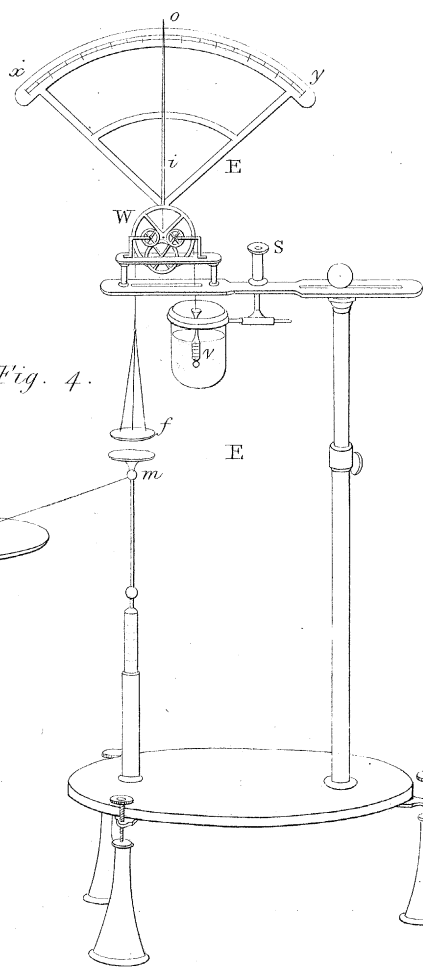
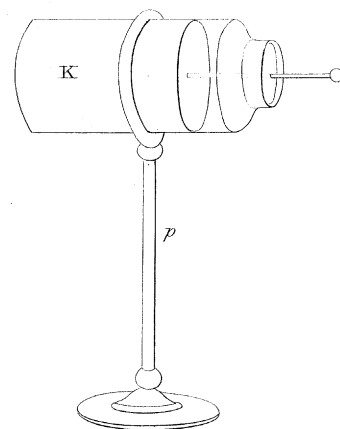

Fig. 4.

Fig. 9.

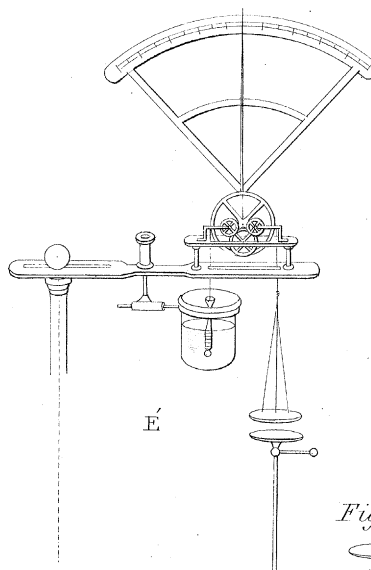

Fig. 8.

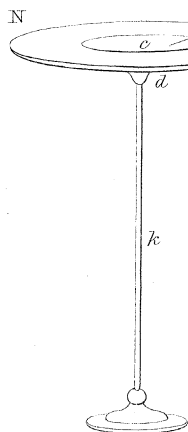
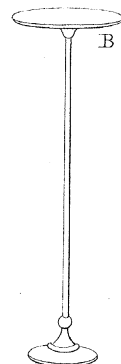

Fig. 5.

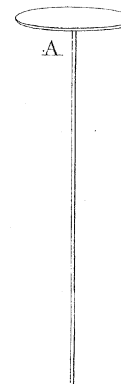

Fig. 6.

